



# Automotive Lamp Catalogue

Katalog autožárovek  
Katalog Żarówek Samochodowych  
Lichtprogramm Fahrzeuglampen

Imagination at work



 **GE Home & Business Solutions** poskytuje široký sortiment výrobků a služeb po celém světě, včetně elektrických spotřebičů a řešení světelné a elektrické distribuce. Ve více než 100 zemích používá GE Home & Business Solutions pro poskytování řešení pro komerční, průmyslové a domácí použití inovační technologie a „ecoimagination“, GE iniciativa průbojně přináší na trh nové technologie, které pomáhají zákazníkům a spotřebitelům vyhovět nálehačným požadavkům, přispívajícím ke zlepšení životního prostředí. GE rozsáhle investuje do vývoje a výzkumu, a proto můžeme nabídnout značně výhodná řešení, která mohou vyhovět technickým a kvalitativním specifikacím našich zákazníků.

GE Lighting – divize GE Home & Business Solutions – je jedním z největších dodavatelů světelných zdrojů na světě, který poskytuje nejmodernější technologie, nabízí úplný sortiment žárovek, halogenových žárovek, zářivek, kompaktních zářivek, výbojek a autožárovek. GE zaujímá od začátku vedoucí roli v automobilovém osvětlení, nyní nabízí kompletní řadu automobilových žárovek pro napětí 12V a 24V. Řada automobilových žárovek vyráběná v Evropě, která je zahrnuta v tomto katalogu, je prodávána po celém světě jak pro použití ve světlometech u prvoosazovatelů, tak i pro použití na trhu. Na požádání je k dispozici i samostatný katalog pro GE autožárovky určené pro severoamerický trh.

 **GE Home & Business Solutions** bietet Ihnen eine weltweit breite Palette von Produkten und Dienstleistungen für Haushaltsgeräte, Beleuchtung und elektrische Verteilersysteme an. GE Home & Business Solutions bietet Lösungen für Gewerbe, Industrie und private Haushalte in mehr als 100 Ländern. GE Home & Business Solutions bietet innovative Technologie und „Ecoimagination“, eine Initiative von GE, um mit neuen Technologien die Herausforderungen für eine saubere Umwelt zu meistern. GE Lighting – ein Teil von GE Home & Business Solutions – ist einer der größten Hersteller von Lichtquellen mit modernster Technologie und bietet das gesamte Spektrum an Glüh-, Halogen-, Leuchtstoff-, Kompaktleuchtstoff- und Gasentladungslampen einschließlich Automobilbeleuchtung.

GE hatte von Anfang an eine führende Rolle in der Automobilbeleuchtung und bietet heute ein breites Spektrum im 12V und 24V Segment, sowohl für die Erstausrüstung als auch für den Aftermarket. Die Produktpalette für Automobilbeleuchtung in diesem Katalog wird überwiegend in Europa hergestellt. Auf Anfrage senden wir gerne einen Katalog von GE Lighting Nord Amerika für die Automobilbeleuchtung.

 **GE Home & Business Solutions** oferuje szeroki asortyment produktów takich jak sprzęt AGD, oświetlenie oraz rozwiązania rozdzielni energii elektrycznej na całym świecie. Oferując rozwiązania dla przemysłu, sektora komercyjnego oraz budownictwa mieszkaniowego w ponad 100 krajach GE Home & Business Solutions stosuje intensywnie innowacyjne technologie oraz program GE o nazwie „ecoimagination” pomagając naszym klientom w spełnianiu coraz większych wymagań ochrony środowiska. GE intensywnie inwestuje w badania i rozwój i możemy obecnie zaoferować ciekawe rozwiązania, które mogą spełnić zarówno techniczne jak też jakościowe wymagania naszych klientów. GE Lighting – oddział GE Home & Business Solutions – jest jednym z największych dostawców źródeł światła na świecie zapewniając produkty o najwyższym poziomie technicznym. GE Lighting oferuje pełny asortyment lamp żarowych, halogenowych, wysokoprężnych (HID), świetlówek kompaktowych oraz żarówek samochodowych. Od początku istnienia przemysłu samochodowego GE odgrywało czołową rolę w oświetleniu pojazdów samochodowych i obecnie oferuje pełen typoszereg żarówek samochodowych na napięcie 12V i 24V. Nasze żarówki samochodowe produkowane w Europie, sprzedawane są na całym świecie zarówno do producentów oświetlenia samochodowego jak też na rynku wymiany. Na życzenie dostępny jest oddzielny katalog żarówek samochodowych GE Lighting zawierający żarówki przeznaczone na rynki Ameryki Północnej.

 **GE Home & Business Solutions** provides a broad range of products and services throughout the world, including appliances, lighting and electrical distribution solutions. Providing solutions for commercial, industrial and residential use in more than 100 countries, GE Home & Business Solutions uses innovative technologies and „Ecoimagination”, a GE initiative to aggressively bring to market new technologies that help customers and consumers meet pressing environmental challenges. GE Lighting – a division of GE Home & Business Solutions – is one of the largest suppliers of light sources in the world. We provide state-of-the-art technology and are able to offer a full range of incandescent lamps, Fluorescent lighting products, Halogen, HID, Compact fluorescent and Automotive lamps. GE has played a leading role in Automotive Lighting for many years. Nowadays we are able to offer a full range of vehicle lamps operating on either 12V or 24V systems. The automotive product range produced in Europe – which is included in this catalogue – is sold all over the world, both for original equipment use and for use in the aftermarket. Upon request a separate catalogue is available on the GE Lighting North American Automotive range.



# Certification

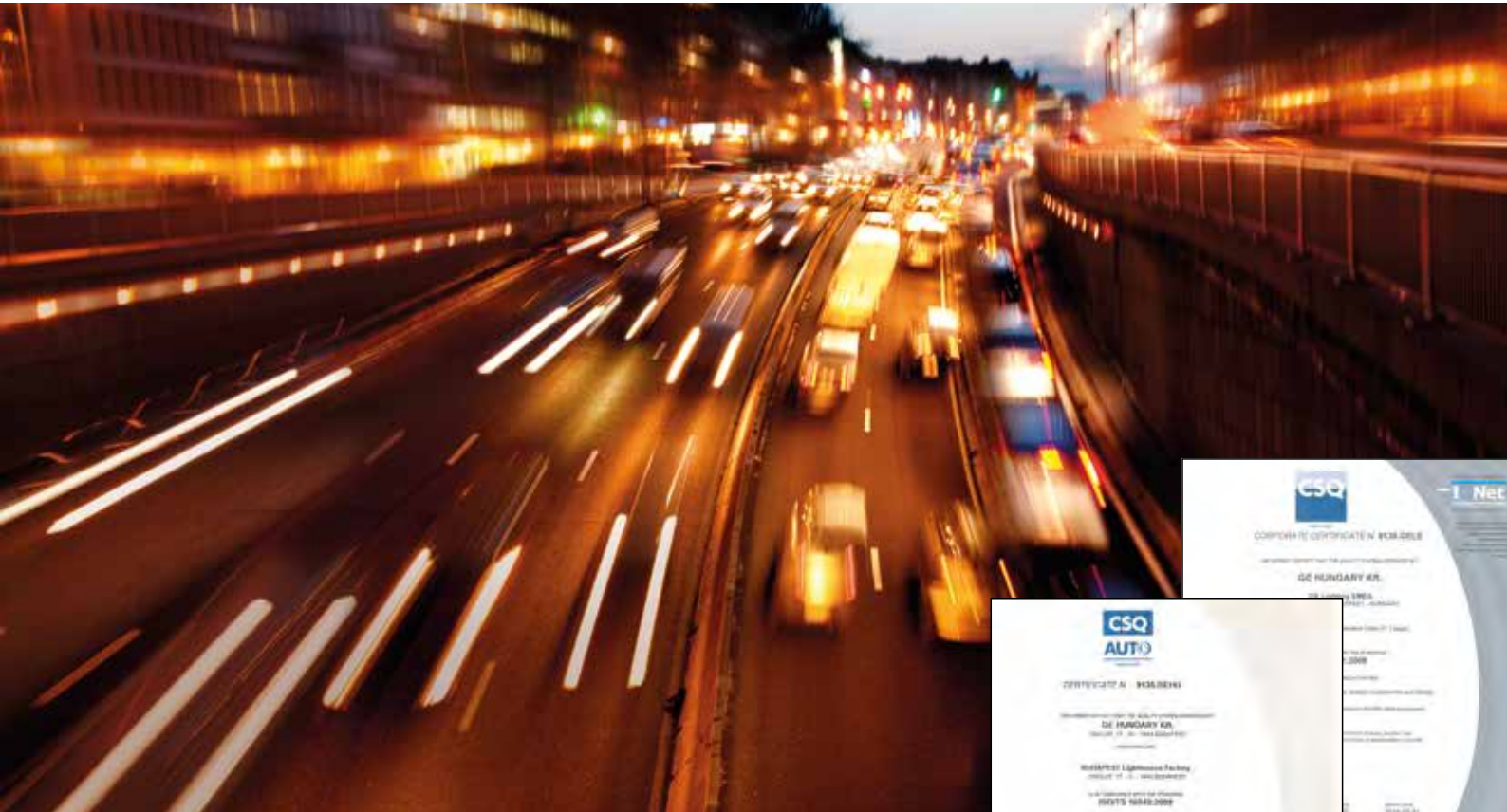

 Společnost je na schváleném seznamu mnoha světových výrobců automobilů, u kterých je klíčovým měřítkem kvalita a výkonnost. Spolehlivá kvalita automobilových žárovek je zaručena:

- Počítačově řízeným a kontrolovaným konstrukčním procesem
- Plně automatizovanými výrobními linkami
- Vysokou úrovní systému zajištění kvality.

 Nasza firma posiada certyfikaty wielu światowych producentów samochodów, dla których jakość oraz parametry są zasadniczymi elementami kwalifikacji. Wysoka jakość naszych żarówek samochodowych jest zapewniana przez:

- Proces produkcyjny sterowany i kontrolowany komputerowo
- Całkowicie zautomatyzowane linie produkcyjne
- Wysoki poziom systemu zapewnienia jakości

 Unser Unternehmen befindet sich auf den meisten Freigabelisten der weltweiten Automobilindustrie, dort wird der Schwerpunkt auf Qualität und Leistungsfähigkeit gesetzt.

Die verlässliche Qualität der Automobillampen wird erreicht durch

- computergestützte 100% Qualitätskontrolle
- vollautomatische Produktionsverfahren
- hochentwickelte Qualitätssicherungssysteme

 The company is on the Approval list of many of the worlds car manufacturers, where quality and performance are key measurements. The reliability and quality of automotive lamps is ensured by:

- Computer-managed and controlled design process
- Fully automated production lines
- High level of quality assurance system
- Continued investment programs
- A commitment to continuous improvement



ISO 9001, ISO TS 16949 and ISO 14001 quality system certification



ECE compliance, homologation



Global OEM customer base

EoLV, ROHS compliance



Use of UV cut glass, safe for use in plastic headlights

# Obsah – Legenda – Einführung – Contents

Introduction, Certification, Contents, Automotive Lamps	2-7
Úvod, Certifikace, Obsah, Automobilové žárovky - Wprowadzenie, Spis treści, Legenda - Einführung	
"XENSATION™" - D1S, D1R, D2S, D2R, D3S, D3R, D4S, D4R headlight lamps	8-9
"XENSATION™" - D1S, D1R, D2S, D2R, D3S, D3R, D4S, D4R výbojky do hlavních světlometů – "XENSATION™" – D1S, D1R, D2S, D2R, D3S, D3R, D4S, D4R Lampy ksenonowe do reflektorów głównych – 12V SAE-Hauptscheinwerferlampen D1S, D1R, D2S, D2R, D3S, D3R, D4S, D4R	
12V halogen headlight lamps - "PREMIUM"	10-11
12V halogenové žárovky do hlavních světlometů – "PREMIUM" – Žárovky halogenowe "PREMIUM" 12V – Halogen Scheinwerferlampen	
MEGALIGHT ULTRA +120	12-13
MEGALIGHT ULTRA +90	14-15
MEGALIGHT PLUS	16-17
SPORTLIGHT - incl. miniature lamps	18-19
SPORTLIGHT ULTRA	20-21
EXTRA LIFE - incl. miniature lamps	22-23
RALLY - OFF ROAD	24
Adjustable LED Daytime Running Lamp	25
MOTORCYCLE	26
12V Headlight lamps - R2, H4 - upper and lower beam, H1, H2, H3, H7, H8, H9, H10, H11, HB3, HB4 - single filament lamps	27
12V Dvouvláknové žárovky do hlavních světlometů – R2, H4, jednovláknové žárovky H1, H2, H3, H7, H8, H9, H10, H11, HB3, HB4 – 12V Žárovky do reflektorů hlavních – R2, H4 – Światła drogowe i mijania, H1, H2, H3, H7, H8, H9, H10, H11, HB3, HB4 – Žárovky jednožarnikowe - 12V Zweifaden-Hauptscheinwerferlampen R2, H4, Einfadenlampen H1, H2, H3, H7, H8, H9, H10, H11, HB3, HB4	
Miniature lamps - "PREMIUM"	28-29
Miniaturní žárovky – "PREMIUM" – Žárovky miniaturové – "PREMIUM" – Miniaturlampen	
12V Tail, stop and direction lamps	30
Žárovky pro obrysová, brzdová a směrová světla – Žárovky pozycijne, stopowe i do kierunkowskazów – Brems-, Blink- und Schlußlichtlampen	
12V Interior lamps, miniature halogen lamps	31
Žárovky pro vnitřní osvětlení, miniaturní halogenové žárovky – Žárovky do osvětlení wewnętrznego, žárovky halogenowe miniaturové – Lampen für Innenbeleuchtung, Miniatur-Halogenlampen	
12V Tail, direction, parking and indicator lamps	32
Žárovky pro obrysová, brzdová a směrová světla – Žárovky pozycijne, stopowe i do kierunkowskazów – Blink-, Brems- und Schlußlichtlampen	
12V Wedge base lamps with and without plastic cap	33
Celoskleněné žárovky a žárovky s plastovou patičkou – Žárovki całoszklane lub z trzonkiem plastikowym – Glassockellampen mit und ohne Steckfassung	
"Heavy Star" - Heavy Duty Long Life - 24V Truck lamps with longer life and increased robustness	34-35
24V Žárovky pro nákladní automobily s delší životností a zvýšenou robustností – Žárovki 24V o dużej trwałości i wzmocnionej konstrukcji do samochodów ciężarowych – 24V Lampen für LKW und Busse mit längerer Lebensdauer und höherer Robustheit	
24V Headlight lamps – upper and lower beam	36
Žárovky do hlavních světlometů – Žárovki do reflektorów głównych - światła drogowe i mijania – Hauptscheinwerferlampen	
24V Tail, direction, parking and indicator lamps	37-38
Žárovky pro obrysová, brzdová a směrová světla – Žárovki pozycijne, stopowe i do kierunkowskazów – Blink-, Brems- und Schlußlichtlampen	
24V Interior lamps	39
Žárovky pro vnitřní osvětlení – Žárovki do osvětlení wewnętrznego – Lampen für Innenbeleuchtung	
24V Tail, stop and direction lamps	39
Žárovky pro obrysová, brzdová a směrová světla – Žárovki pozycijne, stopowe i do kierunkowskazów – Brems-, Blink- und Schlußlichtlampen	
Zestavy žárovek samochodových – Lamp kits	40
Ekspozitory – Displays	41
Balení – Opakowania – Verpackungen – Packaging, blisters	42-44
Piktogramy – Piktogramy – Piktogramme – Symbols, marking	45
Patice žárovek – Trzonki do žárovek – Sockelübersicht – Lamp bases	46
GE Lighting kontakty – GE Lighting kontakty – GE Lighting Kontakten – GE Lighting contacts	47-48

## Legend

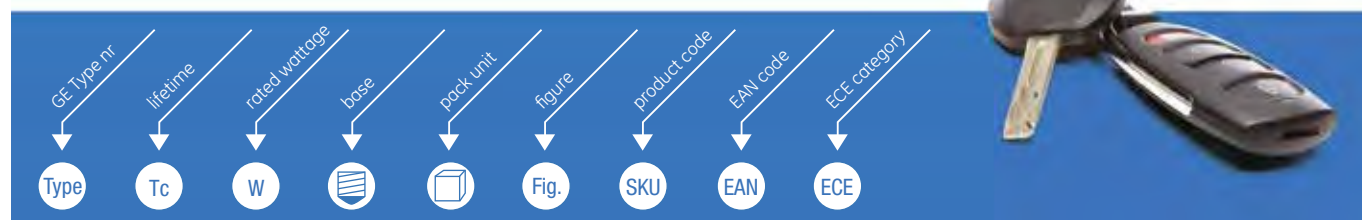

# 12V Automotive Lamps

**front light**

D1S 53620	D1R 53740	D2S 53500	D2R 53510	D3S 53660	D3R 53730	D4S 53670	D4R 53680	H1 50310/1U	H3 50340U	H4 50440U	H7 58520U	H9 53100HU	H11 53110HU	HB3 53060U	HB4 53070U
--------------	--------------	--------------	--------------	--------------	--------------	--------------	--------------	----------------	--------------	--------------	--------------	---------------	----------------	---------------	---------------

**side turn signals**

W5W 501	WY5W 501NA	T4W 2662
------------	---------------	-------------

**parking light**

T4W 2662	W5W 501	W5W NB 501 NB	H6W 52830U
-------------	------------	---------------------	---------------

**fog light**

H1 50310/1U	H3 50340U	H7 58520U	H8 53090HU	H10 53080U	H11 53110HU
----------------	--------------	--------------	---------------	---------------	----------------

**side signals, warning lights**

P21W 1057	PY21W 1056	W21W 7440	WY21W 7440NA
--------------	---------------	--------------	-----------------

**dashboard and interior light**

W5W 501	W3W 504	1.2W 5301	T4W 2662	C5W 7546	fest 10W 7576	H6W 52830U
------------	------------	--------------	-------------	-------------	---------------------	---------------

**parking lights**

R5W 2619	R10W 2641	P21/5W 1077	P21/4W 1122	W21/5W 7443
-------------	--------------	----------------	----------------	----------------

**stop light (CHMSL)**

W5W 501	W16W 921
------------	-------------

**license plate**

R5W 2619	C5W 7546	W5W 501	T4W 2662
-------------	-------------	------------	-------------

**side signals, warning lights**

P21W 1057	PY21W 1056	W21W 7440	WY21W 7440NA
--------------	---------------	--------------	-----------------

**trunk light**

R5W 2619	C5W 7546	fest 10W 7576
-------------	-------------	------------------

**stop lights**

P21W 1057	P21/5W 1077	P21/4W 1122	W21/5W 7443	W21W 7440
--------------	----------------	----------------	----------------	--------------

**fog lights**

P21W 1057	W21W 7440
--------------	--------------

**reverse light**

P21W 1057	W16W 921	W21W 7440
--------------	-------------	--------------

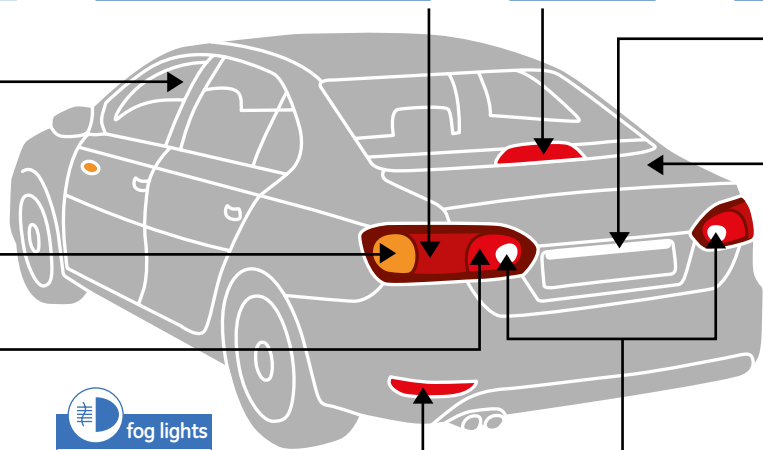
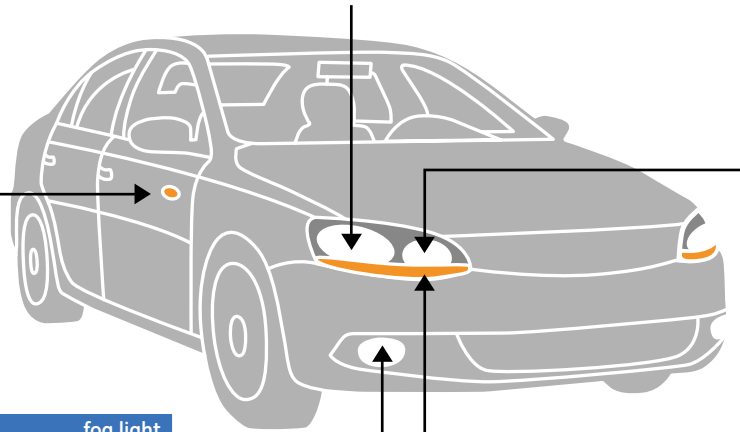

# 24V Commercial Vehicles

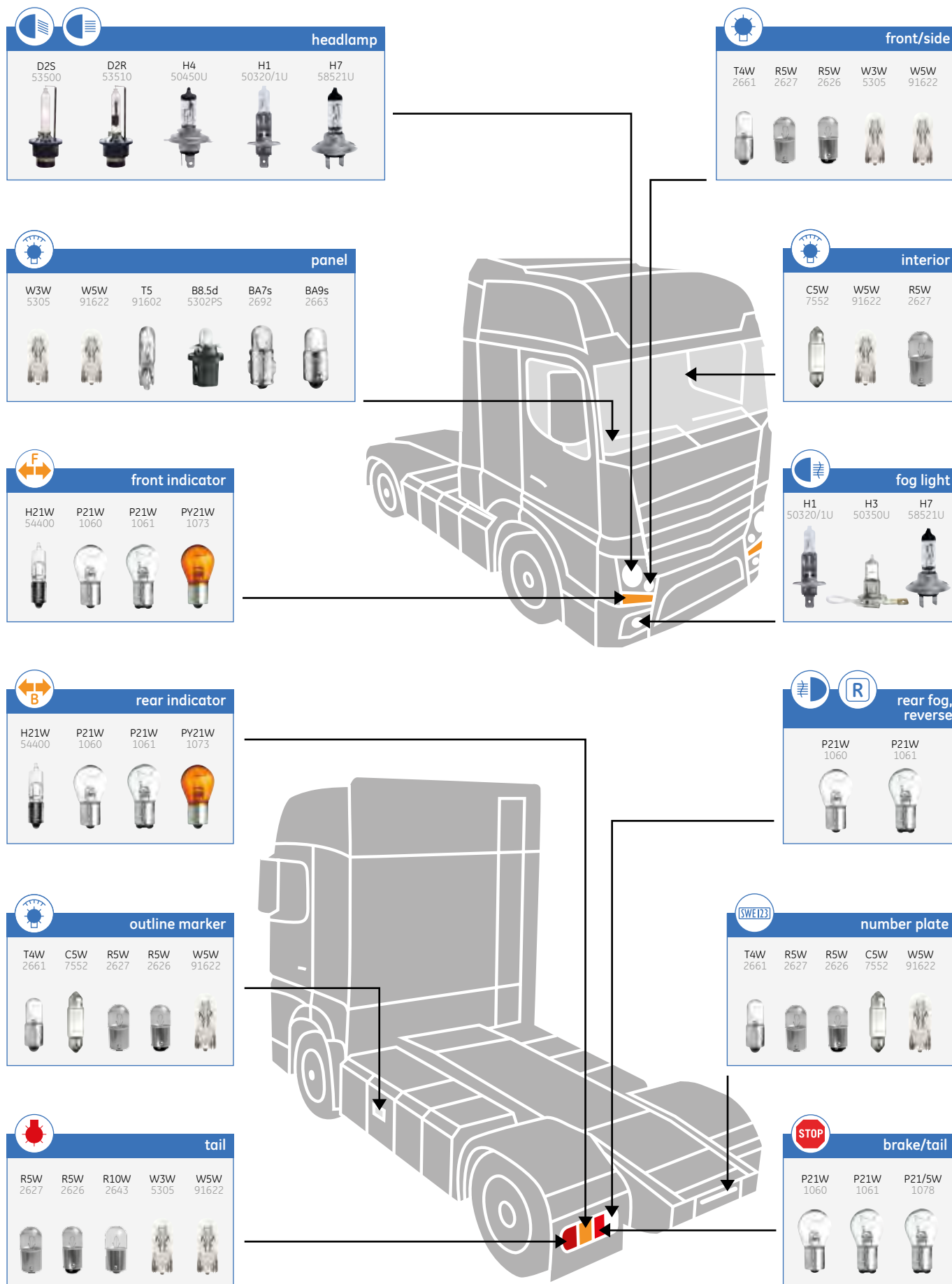

# Motorcycles

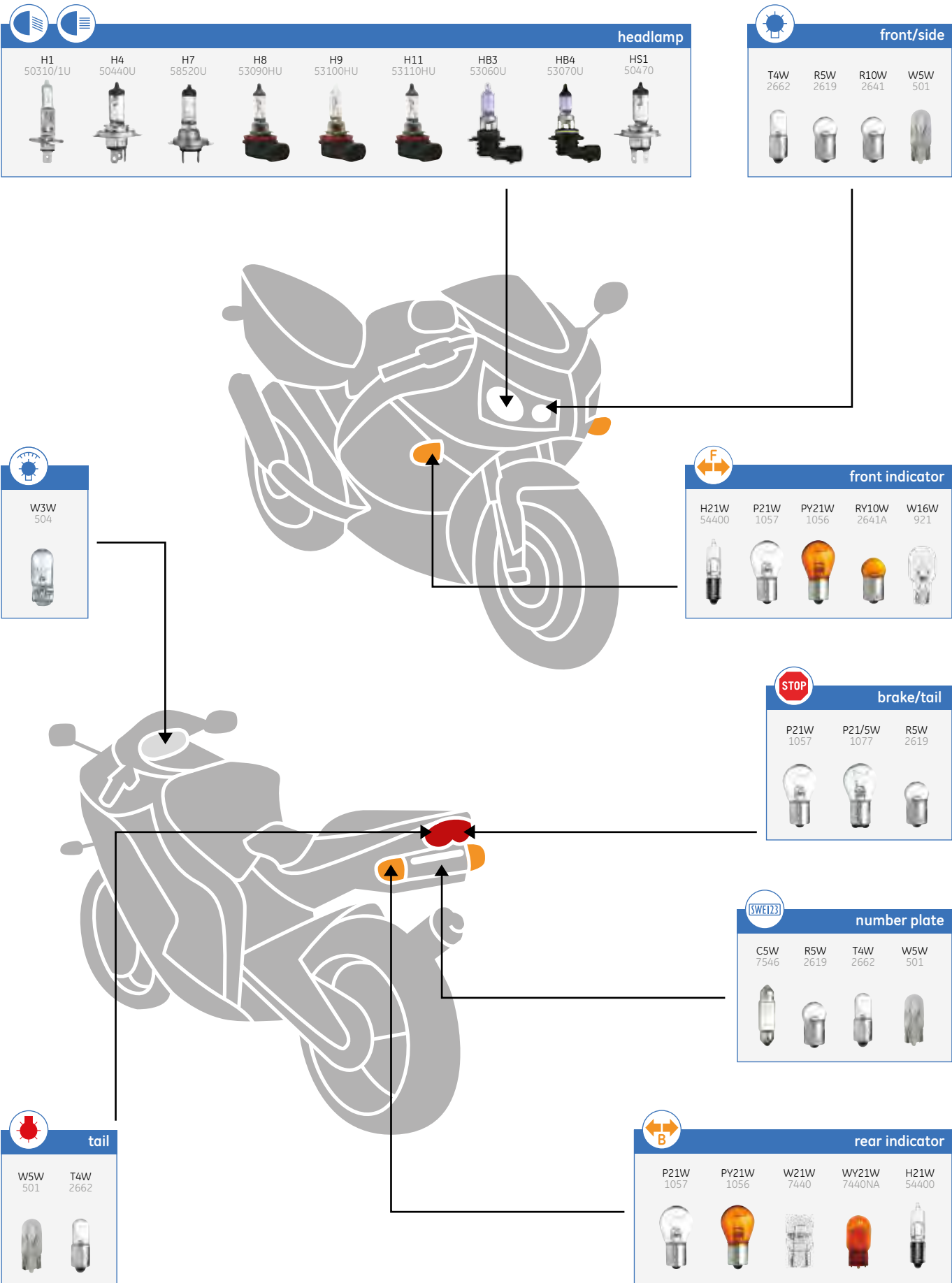

# Xenon High Intensity Discharge lamps



- Thanks to our latest lighting technology, GE Xensation lamps provide a major leap in road safety over conventional halogen lamps due to enormous increase in the illuminated field of vision.
- Better visibility and illumination- the light emitted provides the driver with many benefits. It assists the human eye and allows better visibility and improved hazard awareness, allowing the driver to navigate poor driving conditions with increased confidence and with less fatigue.
- Lower power consumption – 35W only instead of 55W (ordinary halogen lamp power consumption).
- Better durability – excellent vibration and shock resistance giving significantly greater reliability.
- Optically advantageous whiter light compared to halogen lamps designed to give a colour that is closer to natural daylight.

Type	Color temperature (Kelvin)
Xensation Standard D1, D2, D3, D4	4200
White Xensation D1, D2	4800*

\* Colour temperature exceeds 5500K in majority of life time.

## GE 4800K\* D1 & D2 lamps White Xensation

4800 kelvin



4200 kelvin

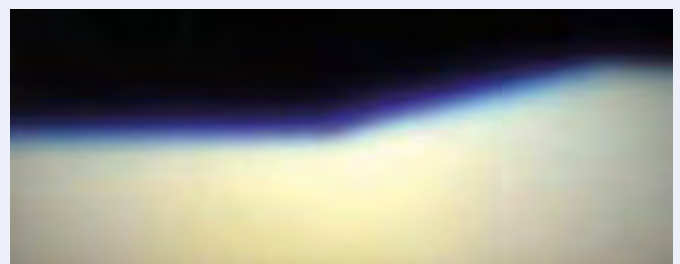

Light up the road with style and brilliant white light

### Up to 20% more light on the road - maximum illuminance

- Produces a crisp, bright light that is closer to daylight.
- Better visibility in extreme weather conditions, higher visibility in peripheral areas.
- Less fatigue effect during night driving.



# D1S, D1R, D2S, D2R, D3S, D3R, D4S, D4R

Type	ECE	W			Fig.	SKU	EAN
------	-----	---	--	--	------	-----	-----

## Xenon-HID – Headlight lamps

Žárovky do hlavných svetlometů  
 Żarówky do reflektorów głównych - światła drogowe i mijania  
 Hauptscheinwerferlampen  
 Headlight lamps – upper and lower beam

53620	D1S	35	PK32D-2	1/4/12	1	78129	0043168781299
53740	D1R	35	P32D-3	1/4/12	2	93011095	0064894504440
53500	D2S	35	P32D-2	1/8/32	3	93036	0043168930369
53500	D2S	35	P32D-2	1/3/12	3	20077	0043168930369
53510	D2R	35	P32D-3	1/8/32	4	93218	0043168932189
53510	D2R	35	P32D-3	1/3/12	4	20079	0043168932189
53660	D3S	35	PK32D-5	1/4/12	1	14178	0043168141789
53730	D3R	35	PK32D-6	1/4/12	2	93011085	0064894504457
53670	D4S	35	P32D-5	1/3/12	3	14185	0043168141857
53680	D4R	35	P32D-6	1/3/12	4	14186	0043168141864
<b>NEW</b> 53750 - 4800K*	D1S	35	PK32d-2	1/4/12	5	93021374	64894530760
<b>NEW</b> 53760 - 4800K*	D2S	35	P32d-2	1/3/12	6	93019380	64894530333
<b>NEW</b> 53770 - 4800K*	D2R	35	P32d-3	1/3/12	7	93019901	64894530357

\* Colour temperature exceeds 5500K in majority of life time.

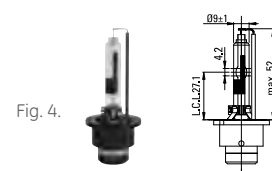
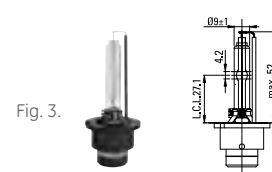
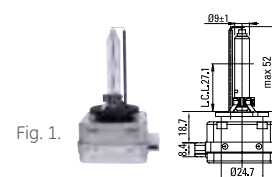



# Halogen headlight lamps

*lighting your way...*

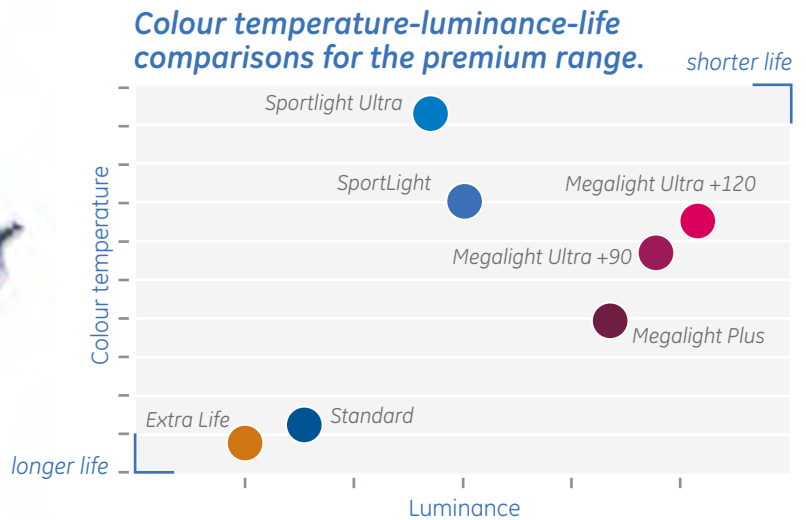
As well as the basic range, GE automotive also offers the premium range, based on special lamp designs. The premium range includes: Megalight Ultra +120, Megalight Ultra +90, Megalight Plus, Sportlight, Extra Life, Heavy Star, Rally. The premium lamps have additional benefits in terms of life, colour, vibration resistance or wattage. The premium lamps are also E1 marked, making their use on the EU roads possible, with the exception of Rally lamps that were designed for off-road usage. Extra life lamps have enhanced life, Megalight Plus and Ultra lamps possess increased luminance, Sportlight halogen lamps give intense blue-white light.



## UPGRADE your car with GE premium lamps

			
	H1	H3	H4
<b>Megalight Ultra +120</b> up to 120% more light	●		●
<b>Megalight Ultra +90</b> up to 90% more light	●		●
<b>Megalight Plus</b> 50-60% more light	●		●
<b>SportLight</b> when you really want to <b>see and be seen</b>	●		●
<b>Sportlight Ultra</b> Intense white light comparable with xenon – 4200 Kelvin	●		●
<b>Extra Life</b> better economy for daytime lighting	●	●	●
<b>Heavy Star - 24V</b> Longer life, increased robustness	●	●	●
<b>Rally</b> for <b>off-road</b> use only	●	●	●
<b>GE "Reliable" range</b> quality- performance fully replacable with OEM lamps	●	●	●

**Operational voltage** is a critical parameter influencing the life time of the automotive lamps. The life of the lamp is sensitive to the operation voltage of the car, 1% of change of the voltage results in 12-15% change of life with opposite sign.

More light  
 Better visibility  
 Improved driving performance

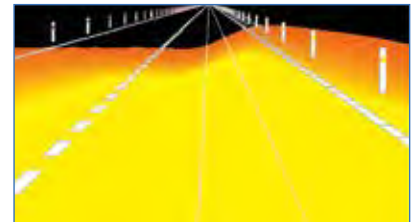
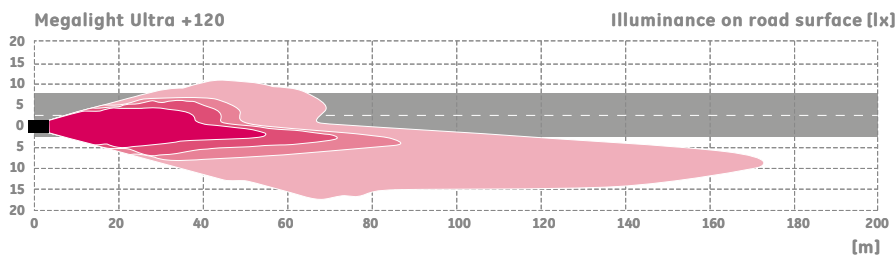
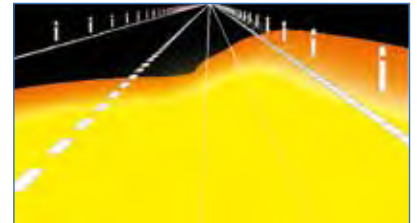
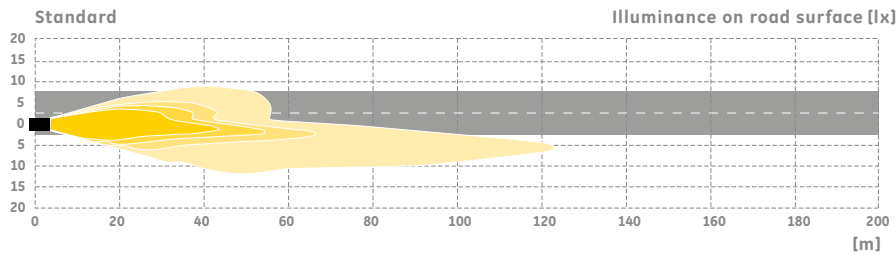

H7	H8	H9	H10	H11	HB3	HB4
●				●	●	●
●				●	●	●
●						
●					●	●
●						
●						
●	●	●	●	●	●	●



The special quartz glass used for GE automotive lamps cuts the UV component of light, it means that GE automotive lamps can safely be used in plastic reflectors without the risk of discoloration.

# Megalight Ultra +120



## **O 120% více světla na vozovce**

Nová úroveň výkonu – optimalizovaná konstrukce s použitím 100% xenonu jako plnicího plynu

- Nejintenzivnější a nejvýkonnější úroveň osvětlení z hlediska svítivosti, pro bezpečnější řízení
- Zvýšená úroveň svítivosti světlometu pomáhá v redukci nehod v nočním čase / za podmínek snížené viditelnosti



## **Do 120% więcej światła na drodze**

Ulepszone działanie - optymalna konstrukcja żarówki napelnionej w 100% Ksenonem

- Intensywne i mocne światło żarówki dla bezpieczniejszej jazdy
- Poprawa poziomu oświetlenia reflektorów głównych pomaga zmniejszyć ilość wypadków podczas jazdy nocą i w warunkach słabej widoczności



## **Bis zu 120% mehr Licht auf der Straße**

Neues Leistungsniveau – Prozessoptimiertes Design mit 100 %-iger Xenongasfüllung.

- Intensivste und Leistungsstärkste Lampe in Bezug auf Helligkeit, sorgt für sicheres Fahren
- Erhöht die Lichtintensität des Scheinwerfers und verringert somit die Unfallgefahr bei Dunkelheit
- Verbesserte Lichtintensität hilft bei der Verringerung von Unfällen in der Nacht und bei schlechten Sichtverhältnissen



## **Up to 120% more light on the road**

New level of performance - optimized design with 100% xenon gas fill.

- Most intense and powerful lamp in terms of luminance, for safer driving
- Improved headlamp illumination level helps in reduction of accidents at night time/in poor visibility conditions



--	--	--	--	--	--	--	--	--

## Megalight Ultra +120 - Halogen headlight lamps

Halogenové žiarovky do hlavných svetlometů  
 Żarówki halogenowe do reflektorów głównych - światła drogowe i mijania  
 Hauptscheinwerferlampen  
 Headlight lamps - upper and lower beam

<b>50440SNU</b>	250	H4	60/55	P43t	2/18/72 display	1	98241	0043168982634
					2/20 blister	1	98281	0043168982818
<b>58520SNU</b>	250	H7	55	PX26d	2/18/72 display	2	98264	0043168982658
					2/20 blister	2	98282	0043168982825
<b>50310NU</b>	250	H1	55	P14,5s	2/18/72 display	3	98239	0043168982405
					2/20 blister	3	98266	0043168982665
<b>53810NU</b>	200	HB3	60	P20d	2/18/72 display	4	98436	0043168987325
<b>53070SNU</b>	250	HB4	51	P22d	2/18/72 display	5	98437	0043168987332
<b>53110SNU</b>	250	H11	55	PGJ19-2	2/18/72 display	6	98438	0043168987349

\* **Tc (hour)** is the time up to which 63,2 % of tested lamps have ended their lives. Measured according to GE life test specification. The life of the lamp is sensitive to the operation voltage of the car, 1% of change of the voltage results in 12-15% change of life with opposite sign.

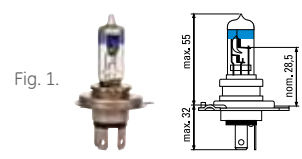

Fig. 1.

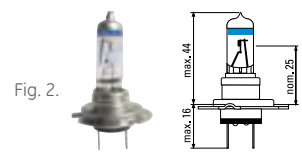

Fig. 2.

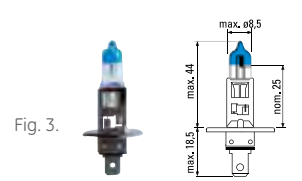

Fig. 3.

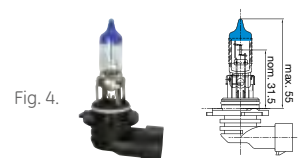

Fig. 4.

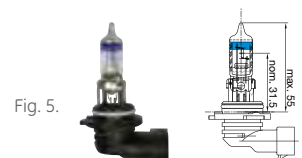

Fig. 5.

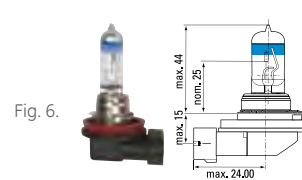

Fig. 6.



# Megalight Ultra +90



## ***O 90% více světla na vozovce***

Vysoce výkonné žárovky pro zvýšenou viditelnost, pohodlí a styl

- Zlepšený noční řidičský komfort
- Větší svítivost v kombinaci s bělejšími světlem zvyšuje bezpečnost vašeho řízení



## ***Do 90% więcej światła w warunkach drogowych***

Žárovky o wysokiej skuteczności, zapewniające lepszą widoczność, wygodę i stylowy wygląd

- Poprawa warunków jazdy w nocy
- Lepsze oświetlenie oraz bielsze światło zwiększa bezpieczeństwo Twojej jazdy



## ***Bis zu 90% mehr Licht auf der Straße***

Verbessern Sie Ihr Fahrverhalten durch stressfreies Sehen, dank des helleren Lichtes

- Verbesserte Sicht bei Nacht.
- Hellere Beleuchtung kombiniert mit blau-weißem Licht bedeutet zusätzliche Sicherheit für Ihre Fahrt.



## ***Up to 90% more light on the road***

High performance lamps for visibility, convenience and style

- Improved driving performance at night
- Greater illumination combined with whiter light add safety to your driving.



--	--	--	--	--	--	--	--	--

## Megalight Ultra +90 - Halogen headlight lamps

Halogenové žárovky do hlavních světlometů  
 Żarówki halogenowe do reflektorów głównych - światła drogowe i mijania  
 Hauptscheinwerferlampen  
 Headlight lamps - upper and lower beam

<b>50440SXU</b>	350	H4	60/55	P43t	2/18/72 display	1	93013070	0043168735001
					2/20 blister	1	74153	0043168741538
<b>58520SXU</b>	350	H7	55	PX26d	2/18/72 display	2	93013272	0043168969239
					2/20 blister	2	74154	0043168741545
<b>50310XU</b>	350	H1	55	P14,5s	2/18/72 display	3	93013273	0043168969468
					2/20 blister	3	96948	0043168969482
<b>53060XU</b>	200	HB3	60	P20d	2/12/48 display	4	79295	0043168792950
<b>53070SXU</b>	350	HB4	51	P22d	2/12/48 display	5	79296	0043168792967
<b>53110SXU</b>	350	H11	55	PGJ19-2	2/12/48 display	6	79297	0043168792974

\* **Tc (hour)** is the time up to which 63,2% of tested lamps have ended their lives. Measured according to GE life test specification. The life of the lamp is sensitive to the operation voltage of the car, 1% of change of the voltage results in 12-15% change of life with opposite sign.

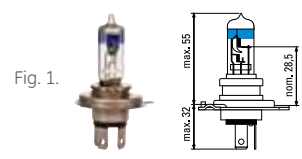

Fig. 1.

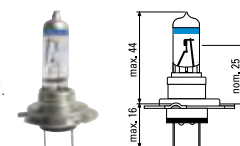

Fig. 2.

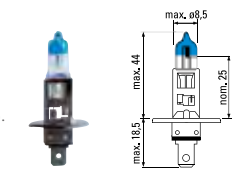

Fig. 3.

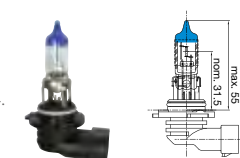

Fig. 4.

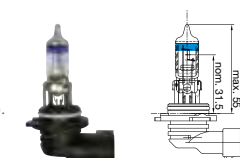

Fig. 5.

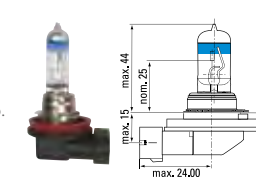

Fig. 6.



# Megalight Plus 50, 60



## ***O 50-60% více světla na vozovce***

- Speciální konstrukce žárovky pro vysokou svítivost
- Delší kužel světla
- Jasnější osvětlení



## ***Do 50-60% więcej światła w warunkach drogowych***

- Specjalna konstrukcja żarówki o wysokiej luminancji
- Większy zasięg wiązki światła z reflektorów
- Jaśniejsze oświetlenie



## ***50-60% mehr Licht auf der Straße***

- Spezielles Design für größtmögliche Beleuchtungsstärke
- Größere Leuchtweite
- Hellere Beleuchtung



## ***Up to 50-60% more light on the road***

- Special high luminance lamp design
- Longer beam
- Brighter illumination





--	--	--	--	--	--	--	--	--

## Megalight Plus 50, 60 - Halogen headlight lamps

Halogenové žárovky do hlavních světlometů  
 Żarówki halogenowe do reflektorów głównych - światła drogowe i mijania  
 Hauptscheinwerferlampen  
 Headlight lamps - upper and lower beam

<b>50440MPU</b>	300	H4	60/55	P43t	2/18/72 display	1	93012268	0043168916189
					1/12/48 display	1	12791	0043168127912
					2/20 blister	1	93361	0043168933612
<b>58520MPU</b>	500	H7	55	PX26d	2/18/72 display	2	93012270	0043168937689
					1/20/80 display	2	12904	0043168129046
					2/20 blister	2	19759	0043168197595
<b>50310MPU</b>	600	H1	55	P14,5s	2/18/72 display	3	93012269	0043168936255
					1/20/80 display	3	12896	0043168128964
					2/20 blister	3	19758	0043168197588

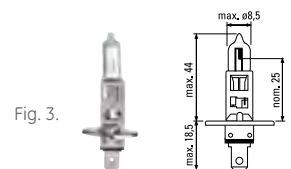
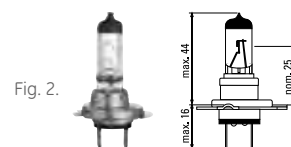
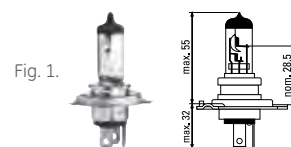

\* **Tc (hour)** is the time up to which 63,2 % of tested lamps have ended their lives. Measured according to GE life test specification. The life of the lamp is sensitive to the operation voltage of the car, 1% of change of the voltage results in 12-15% change of life with opposite sign.





## ***Když opravdu chcete vidět a být viděn***

Intenzivní modrobílé světlo s více jak 50% světla navíc na vozovce

- Vyšší viditelnost v periferním zorném poli
- Lepší viditelnost za extrémních povětrnostních podmínek
- Rychlejší podnět, včasnější varování - miniaturní žárovky



## ***Jeśli naprawdę chcesz widzieć i być widzianym***

Intensywne niebiesko-białe oświetlenie do 50% więcej światła na drodze, wcześniejsza sygnalizacja

- Lepsza postrzegalność przy widzeniu peryferyjnym
- Lepsza widzialność przy złych warunkach pogodowych
- Szybsza sygnalizacja, wcześniejsze ostrzeżenie - żarówki miniaturowe



## ***Wenn Sie wirklich gut sehen und gut gesehen werden wollen***

Intensives blau-weißes Licht mit Xenon Effekt, welches bis zu 50% mehr Licht auf die Straße bringt

- Bessere Sicht in den Außenrandbereichen um zu sehen und gesehen zu werden
- Bessere Sichtbarkeit bei extremen Wetterbedingungen
- Verbesserte und schnellere Reaktionszeit - Miniaturlampen



## ***When you really want to see and be seen***

Intense blue-white light up to 50% more light on the road, or faster signal

- Higher visibility in peripheral viewing
- Better visibility in extreme weather conditions
- Faster signal, earlier notice - miniature lamps



--	--	--	--	--	--	--	--	--

## Sportlight - Halogen headlight lamps *Up to +50% more light on the road*

Halogenové žárovky do hlavních světlometů  
 Żarówki halogenowe do reflektorów głównych - światła drogowe i mijania  
 Hauptscheinwerferlampen  
 Headlight lamps - upper and lower beam

50440SPU	480	H4	60/55	P43t	2/18/72 display	1	93013292	0043168792981
					2/20 blister	1	97132	0043168971324
58520SPU	250	H7	55	PX26d	2/18/72 display	2	93013293	0043168792998
					2/20 blister	2	97131	0043168971317
50310NHSU	130	H1	55	P14,5s	2/18/72 display	3	93013294	0043168907613
					2/20 blister	3	73343	0043168733434
53810NHSU	235	HB3	60	P20d	2/12/48 display	4	79304	0043168793049
53820NHSU	760	HB4	51	P22d	2/12/48 display	5	79303	0043168793032

## Sportlight - Miniature lamps

Žárovky pro obrysová, brzdová a směrová světla  
 Żarówki pozycyjne, stopowe i do kierunkowskazów  
 Blink-, Brems- und Schlußlichtlampen  
 Tail, direction, parking and indicator lamps

1057NH	320	P21W	21	BA15s	1/10/200	6	45690	0043168456906
					10/200	6	45348	0043168453486
1077NH	160/1600	P21/5W	21/5	BAY15d	1/10/200	7	45687	0043168456876
					10/200	7	45346	0043168453462
2619NH	300	R5W	5	BA15s	1/10/200	8	45685	0043168456852
					10/200	8	45342	0043168453424
2641NH	300	R10W	10	BA15s	1/10/200	8	45684	0043168456845
					10/200	8	45337	0043168453370
501NH	500	W5W	5	W2,1x9,5d	10/200	9	76108	0043168761086

\* Tc (hour) is the time up to which 63,2 % of tested lamps have ended their lives. Measured according to GE life test specification. The life of the lamp is sensitive to the operation voltage of the car, 1% of change of the voltage results in 12-15% change of life with opposite sign.

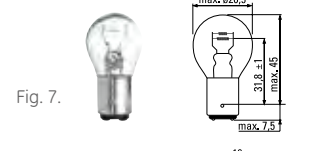
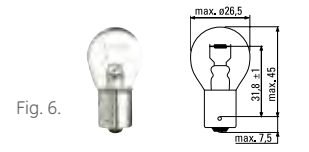
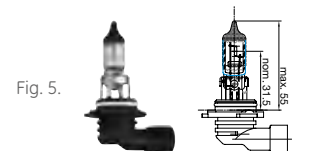
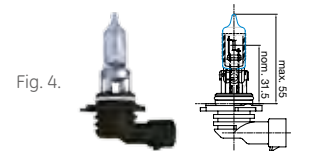
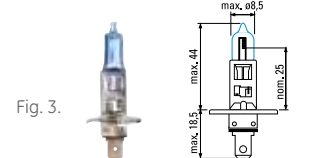
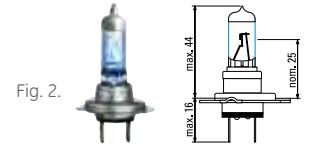
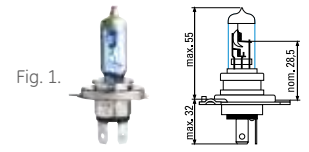

Always change the headlamps by pair.

# Sportlight Ultra 4200 Kelvin



## **Intenzivní bílé světlo srovnatelné s xenovým – 4200 Kelvin**

- Více jak 30% světla navíc na vozovce
- Vyšší viditelnost v periferním zorném poli
- Lepší viditelnost za extrémních povětrnostních podmínek



## **Intensywne białe światło porównywalne ze światłem lamp xenonowych 4200K**

- Do 30% więcej światła na drodze
- Lepsza postrzegalność dla widzenia peryferyjnego
- Lepsza widzialność przy złych warunkach pogodowych



## **Intensives blau-weißes Licht mit Xenon Effekt – 4200 Kelvin**

- Welches bis zu 30% mehr Licht auf die Straße bringt
- Bessere Sicht in den Außenrandbereichen um zu sehen und gesehen zu werden
- Bessere Sichtbarkeit bei extremen Wetterbedingungen



## **Intense white light comparable with xenon – 4200 Kelvin**

- Up to 30% more light on the road
- Higher visibility in peripheral viewing
- Better visibility in extreme weather conditions

--	--	--	--	--	--	--	--	--

## Sportlight Ultra - Halogen headlight lamps *Up to +30% more light on the road, "Xenon look" 4200K*

Halogenové žiarovky do hlavných svetlometů  
 Żarówki halogenowe do reflektorów głównych - światła drogowe i mijania  
 Hauptscheinwerferlampen  
 Headlight lamps - upper and lower beam

<b>50440SBU</b>	250	H4	60/55	P43t	2/18/72	1	90901	0043168909013
					2/20 blister	1	93012846	0064894521812
<b>58520SBU</b>	250	H7	55	PX26d	2/18/72	2	90902	0043168909020
					2/20 blister	2	93012861	0064894521904
<b>50310SBU</b>	250	H1	55	P14,5s	2/18/72	3	90900	0043168909006
					2/20 blister	3	93012845	0064894521805

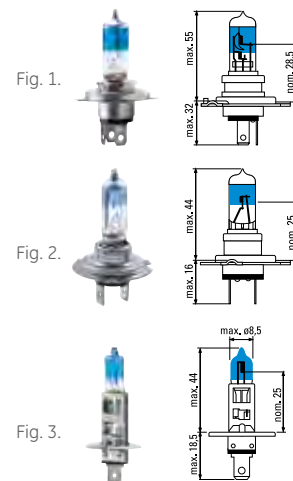

\* **Tc (hour)** is the time up to which 63,2 % of tested lamps have ended their lives. Measured according to GE life test specification. The life of the lamp is sensitive to the operation voltage of the car, 1% of change of the voltage results in 12-15% change of life with opposite sign.



# Extra Life



## **Extrémně dlouhá životnost**

Dvojnásobná životnost ve srovnání se standardními žárovkami

- Vhodné pro denní svícení (DRL)
- Zajišťuje bezpečnou jízdu během dne i noci



## **Verlängerte Lebensdauer / Superlonglife**

Lebensdauerverdoppelung gegenüber Standardglühlampen

- Besonders geeignet auch als Tagfahrlichtlampen-Generation (DRL)
- Sorgt für sicheres Fahren bei Tag und bei Nacht



## **Przedłużona trwałość**

Okres eksploatacji dwukrotnie dłuższy niż w przypadku standardowych żarówek

- Odpowiednie do zastosowania do „światel dziennych” (DRL)
- Zapewnia bezpieczeństwo jazdy w dzień i w nocy



## **Extended long lifetime**

Double the life of standard bulbs

- Suitable for Daytime Running Light (DRL) use
- Ensures safe driving during day and night

--	--	--	--	--	--	--	--	--

## Extra Life - Halogen headlight lamps

Halogenové žárovky do hlavních světlometů  
 Żarówki halogenowe do reflektorów głównych - światła drogowe i mijania  
 Hauptscheinwerferlampen  
 Headlight lamps - upper and lower beam

<b>50440LU_DPU</b>	3500	H4	60/55	P43t	2/18/72 display	1	93012336	0043168174626
					2/20 blister	1	19682	0043168196826
					1/10/100	1	95396	0043168953962
<b>58520LU_DPU</b>	1250	H7	55	PX26d	2/18/72 display	2	93012303	0043168174633
					2/20 blister	2	19686	0043168196864
					1/10/100	2	95397	0043168953979
<b>50310LU_DPU</b>	2000	H1	55	P14,5s	2/18/72 display	3	93012337	0043168174657
					1/10/100	3	93011331	0064894508158
					2/20 blister	3	19685	0043168196857
<b>50340LU_DPU</b>	2500	H3	55	PK22s	1/10/100	4	17464	0043168174640

## Extra Life - Miniature lamps

Žárovky pro obrysová, brzdová a směrová světla  
 Żarówki pozycyjne, stopowe i do kierunkowskazów  
 Blink-, Brems- und Schlußlichtlampen  
 Tail, direction, parking and indicator lamps

<b>1057LFD</b>	1000	P21W	21	BA15s	1/10/200	5	77049	0043168770491
					2/20 blister	5	23284	0043168232845
<b>1056LFD</b>	3000	PY21W	21	BAU15s	1/10/200	6	77091	0043168770910
<b>1077LFD</b>	1000/5000	P21/5W	21/5	BAY15d	1/10/200	7	77050	0043168770507
					2/20 blister	7	23285	0043168232852
<b>TU 1122LFD</b>	1300	P21/4W	21/4	BAZ15d	1/10/200	7	77090	0043168770903
<b>2619LFD</b>	1500	R5W	5	BA15s	1/10/200	8	77051	0043168770514
					2/20 blister	8	23286	0043168232869
<b>TU 2641LFD</b>	1600	R10W	10	BA15s	1/10/200	8	77052	0043168770521
<b>TU 7546LFD</b>	3000	C5W	5	SV8,5	1/10/200	9	77054	0043168770545
<b>TU 930FD</b>	1500	W5W	5	W2,1x9,5d	1/10/200	10	77048	0043168770484
					10/200	10	70244	0043168702447
<b>TU 2662LFD</b>	1500	T4W	4	BA9s	1/10/200	11	77059	0043168770590
					2/20 blister	11	23292	0043168232920
<b>TU 52830LFD</b>	1000	H6W	6	BAX9s	1/10/100	12	77053	0043168770538

\* Tc (hour) is the time up to which 63,2 % of tested lamps have ended their lives. Measured according to GE life test specification. The life of the lamp is sensitive to the operation voltage of the car, 1% of change of the voltage results in 12-15% change of life with opposite sign.

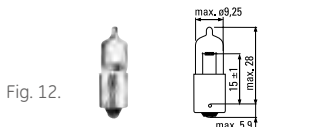
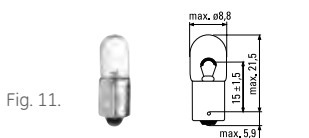
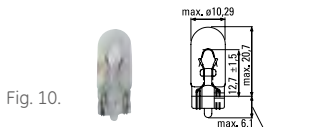
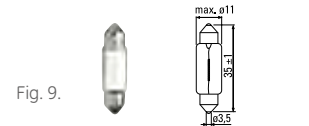
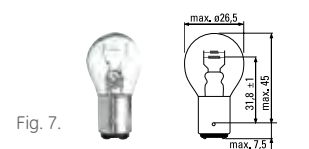
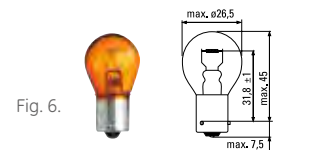
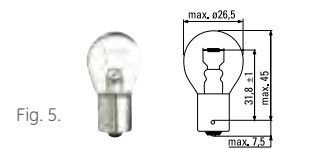
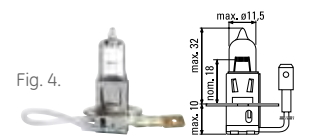
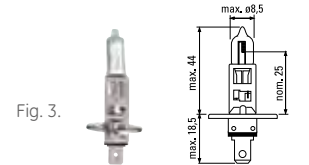
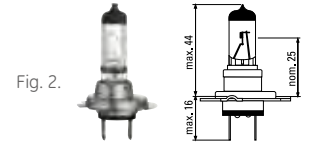
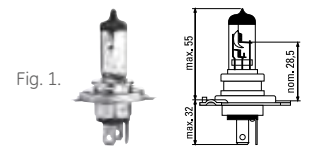

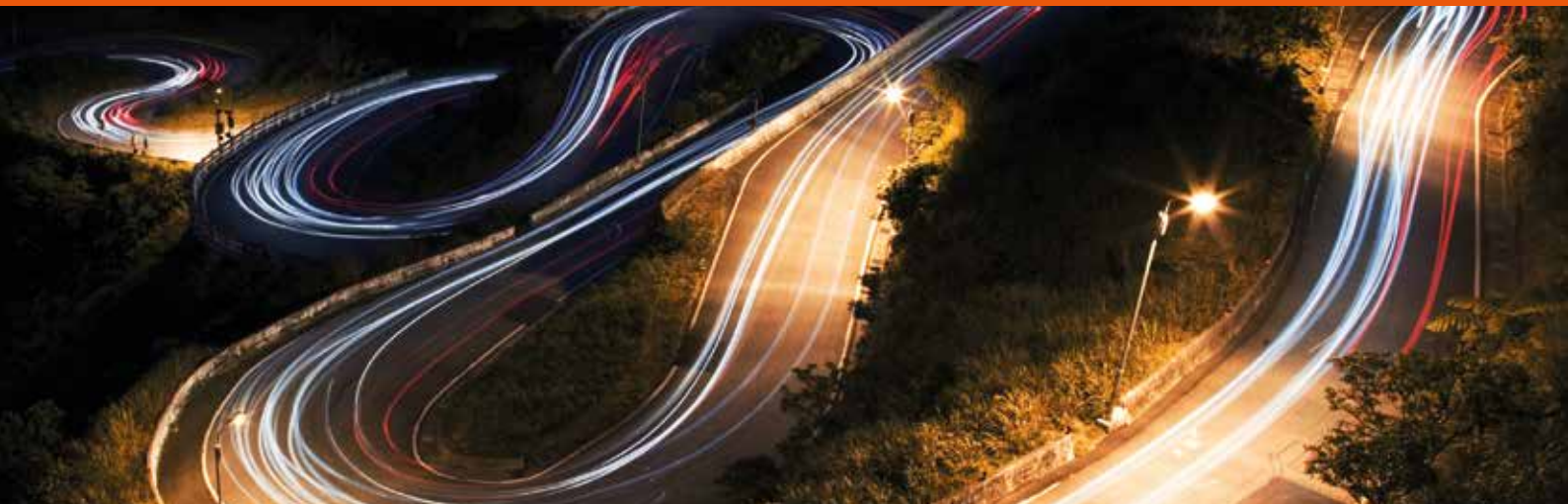

 **Vysokowattové žárovky pro hlavní světlometry a mlhovky pouze pro použití mimo veřejné komunikace**

 **Reflektory przednie i lampy przeciwmgielne wyłącznie do użytku TERENOWEGO (poza drogami publicznymi)**

 **Hochwattscheinwerfer- und Nebelscheinwerferlampen die speziell für „OFF ROAD“ oder als „RALLYLAMPEN“ genutzt werden können.**

 **High wattage headlight and foglight lamps for OFF ROAD use only**



Type	ECE	W			Fig.	SKU	EAN
<b>Rally - Halogen headlight lamps</b>							
52140U		100	P14,5s	1/10/100	1	34874	9004102348740
				1/10 blister	1	35434	0043168354349
50370U		100	P14,5s/R	1/10/100	1	34875	9004102348757
52130U		100	Pk22s	1/10/200	2	34876	9004102348764
				1/10 blister	2	37963	0043168379632
52100HU		100/80	P43t	1/10/100	3	35974	0043168359740
52100HU		100/90	P43t	1/10/100	3	18195	0043168181952
52670HU		140/100	P43t	1/10/100	3	95413	0043168386654
52030U		100/80	P45t	1/10/100	4	35975	0043168359757

Halogenové žárovky do hlavních světlometů – RALLY TYPY nejsou povoleny na veřejných komunikacích  
 Żarówki halogenowe rajdowe do reflektorów głównych – niedozwolone do użytku na drogach publicznych  
 Hauptscheinwerferlampen – Rallye-Typen sind im Bereich der StVZO nicht zugelassen  
 Headlight lamps – Rally types are not allowed on public roads

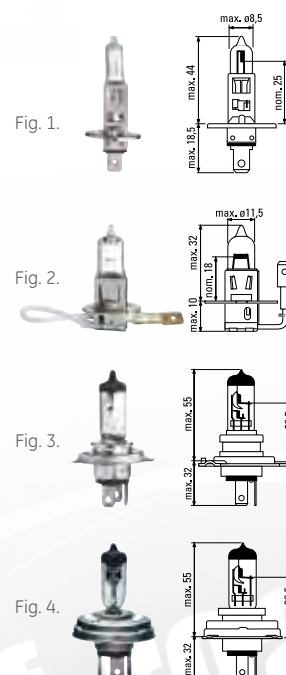



# Adjustable LED Daytime Running Lamp

*Maximum,  
instant visibility*



## What is DRL?

**DRL:** Daytime Running Lights

Lamps are an **automotive lighting device**.

They are mounted in pairs on the front of a motor vehicle and are **constantly switched on while driving**.

The device is designed to illuminate a well-defined light pattern in order to **improve vehicle visibility** during daylight conditions.

## Why DRL?

Many countries have encouraged or required daytime use of low-beam headlamps. After 2011 In EU all new car platforms will come with dedicated DRL units. **Existing car owners have the option to install DRL units** available on the aftermarket to increase vehicle conspicuity, **utilizing these instead of the required low beams**.

Adding daytime light to **existing cars** is beneficial from many aspects: safety, environment, fuel consumption.

## LED DRL vs Low beam used as DRL

- Designed for DRL function
- Energy efficient
- Excellent visibility
- Long life – up to 10x longer operating time when compared to standard Halogen systems



SKU	Description	Pack structure	EAN code
70331	GE LED AUTO DRL31	1/4 (set)	0043168703314

Type	Tc	ECE	W			Fig.	SKU	EAN
------	----	-----	---	--	--	------	-----	-----

Halogenové žiarovky do hlavných svetlometů  
 Żarówki halogenowe do reflektorów głównych - światła drogowe i mijania  
 Hauptscheinwerferlampen  
 Headlight lamps - upper and lower beam

### Multicolor Motorcycle Lamp – Halogen headlight lamps



50440MCU	480	H4	60/55	P43t	1/20	1	84489	0043168844895
58520MCU	250	H7	55	PX26d	1/20	2	84491	0043168844918

### Megalight +120 Motorcycle - Halogen headlight lamps

50440SNU	250	H4	60/55	P43t	1/20	3	98714	0043168987141
58520SNU	250	H7	55	PX26d	1/20	4	98715	0043168987158
53110SNU	250	H11	55	PGJ19-2	1/20	5	98713	0043168987134

### Sportlight +50 Motorcycle – Halogen headlight lamps

50440SPU	480	H4	60/55	P43t	1/20	6	98716	0043168987165
58520SPU	250	H7	55	PX26d	1/20	7	98717	0043168987172
53110SPU	250	H11	55	PGJ19-2	1/20	8	98766	0043168987660

\* Tc (hour) is the time up to which 63,2 % of tested lamps have ended their lives. Measured according to GE life test specification. The life of the lamp is sensitive to the operation voltage of the car, 1% of change of the voltage results in 12-15% change of life with opposite sign.

## Multicolor Motorcycle lamps

Visibly different - see and be seen with our distinctive colour

- unique color that makes you more conspicuous than the rest of the traffic
- up to 30% more light on the road

## Megalight Ultra +120 lamps for motorcycle use

Turn night into day

- New level of performance and safety
- Up to 120% more light on the road

## Sportlight +50 lamps for motorcycle use

Highlight the road ahead

- Intense Blue white light
- Up to 50% more light on the road

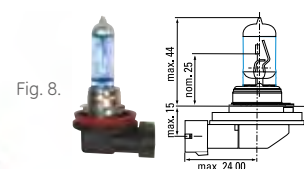
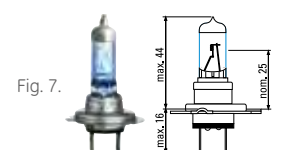
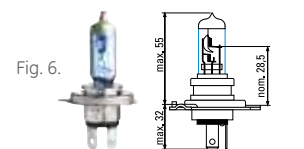
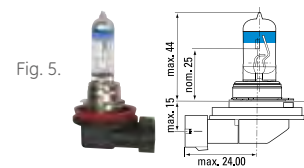
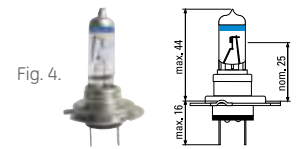
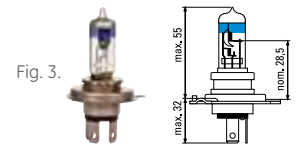
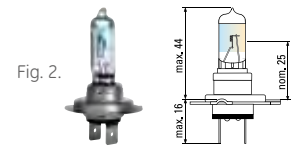
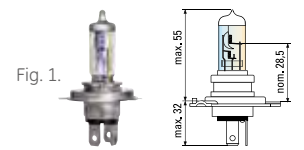

Type	ECE	W			Fig.	SKU	EAN
Halogenové žárovky do hlavních světlometů Żarówki halogenowe do reflektorów głównych - światła drogowe i mijania Hauptscheinwerferlampen Headlight lamps - upper and lower beam							
H4	50440U	H4	60/55	P43t	1/10/100	1 34454	9004102344544
					1/10 blister	1 17120	0043168354417
					2/20 blister	1 35930	0043168359306
	52070U		60/55	P45t	1/10/100	2 19762	0043168197625
H1	50310/1U	H1	55	P14,5s	1/10/100	3 20727	9004102207276
					1/10 blister	3 17119	0043168354301
H3	50340U	H3	55	Pk22s	1/10/200	4 20729	9004102207290
					1/10 blister	4 17117	0043168354325
H7	58520U	H7	55	PX26d	1/10/100	5 35017	0043168350174
					1/10 blister	5 17123	0043168354356
H8	53090HU	H8	35	PGJ19-1	1/10/100	6 92563	0043168925631
					1/10 blister	6 18254	0043168182546
H9	53100HU	H9	65	PGJ19-5	1/10/100	7 92565	0043168925655
					1/10 blister	7 18256	0043168182560
H11	53110HU	H11	55	PGJ19-2	1/10/100	6 92567	0043168925679
					1/10 blister	8 60957	0043168609579
HB3	53060U	HB3	60	P20d	1/10/100	8 36474	0043168364744
					1/10 blister	8 18266	0043168182669
HB4	53070U	HB4	51	P22d	1/10/100	9 36472	0043168364720
					1/10 blister	9 18267	0043168182676
H10	53080U	H10	42	PY20d	1/10/100	9 12905	0043168129053
R2	52950	R2 Halogen	45/40	P45t	1/10/100	10 35077	9004102350774
HIR 2	54430U	HIR 2	55	PX22d	1/6/48	11 96484	0043168964845

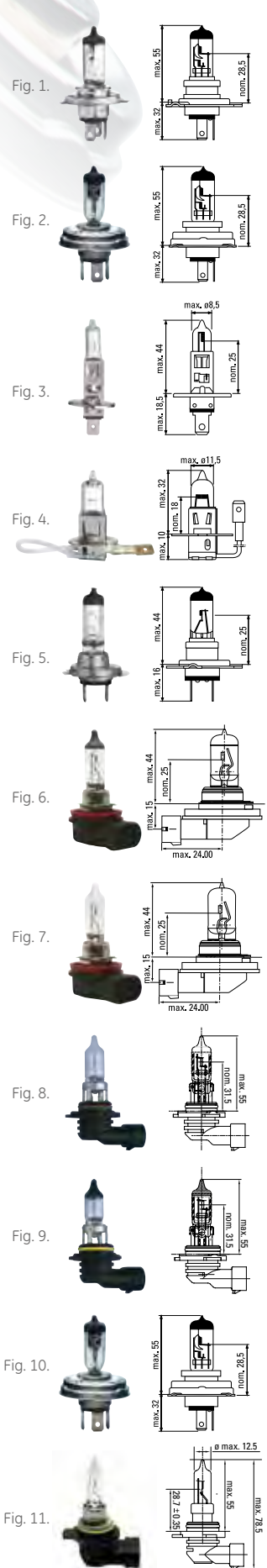

# Miniature lamps



- side signals, warning lamps
- stop lamps
- fog lamps
- license plate
- reverse lamps
- parking lamps
- dashboard lamps
- interior lamps
- indicator lamps
- side turn signal lamps

*UPGRADE* your car with  
**GE premium lamps**

<p><i>Extra Life</i> better economy for daytime lighting, 2x longer life</p>
<p><i>SportLight</i> when you really want to <b>see and be seen</b></p>
<p><i>Heavy Star</i></p>
<p><i>GE "Reliable" range</i> quality- performance fully replacable with OEM lamps</p>

		
P21W	P21/4W	P21/5W
●	●	●
●		●
●		
●	●	●



					
<i>PY21W</i>	<i>R5W</i>	<i>R10W</i>	<i>T4W</i>	<i>W5W</i>	<i>C5W</i>
●	●	●	●	●	●
	●	●		●	
●	●	●	●		
●	●	●	●	●	●

Type	ECE	W			Fig.	SKU	EAN
Žárovky pro obrysová, brzdová a směrová světla Żarowki pozycyjne, stopowe i do kierunkowskazów Brems-, Blink- und Schlußlichtlampen Tail, stop and direction lamps							
1056	PY21W	21	BAU15s	1/10/200	1	37964	0043168379649
				10/200	1	17248	9004102328193
				2/20 blister	1	17133	0043168354073
1057	P21W	21	BA15s	1/10/200	2	37894	0043168378949
				10/200	2	17218	9004102238058
				2/20 blister	2	17131	0043168354066
1058	P21W	21	BA15d	10/200	3	17219	9004102349914
1156		32 CP	BA15s	10/200	2	77369	0043168773690
1077	P21/5W	21/5	BAY15d	1/10/200	5	37896	0043168378963
				10/200	5	17228	9004102238096
				2/20 blister	5	17130	0043168354097
1098		20/5	BA15d	10/200	5	27736	0043168277365
1122	P21/4W	21/4	BAZ15d	10/200	5	17241	9004102238546
				2/20 blister	5	35931	0043168359313
1157	1157 ANSI	32/3 CP	BAY15d	10/200	5	17247	0043168357197
				2/20 blister	5	37969	0043168379694
7440	W21W	21	W3x16d	1/10/100	6	93458	0043168934589
				2/20 blister	6	93447	0043168934473
7440NA	WY21W	21	WX3x16d	1/10/100	7	76090	0043168760904
				2/20 blister	7	76091	0043168760911
7443	W21/5W	21/5	W3x16q	1/10/100	8	93448	00 43168934480
				2/20 blister	8	512863	5994101128631
53990	H21W	21	BAY9S	10/200	9	94714	0043168947145

Fig. 1

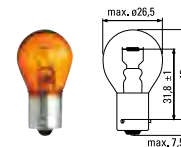

Fig. 2

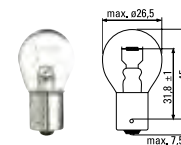

Fig. 3

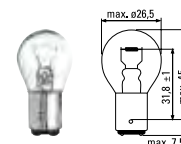

Fig. 4

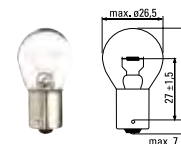

Fig. 5

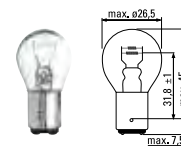

Fig. 6

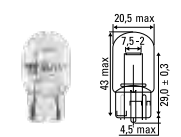

Fig. 7

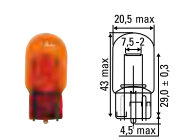

Fig. 8

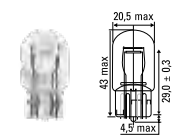
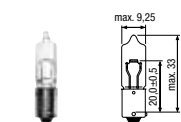

Fig. 9



Type	ECE	W			Fig.	SKU	EAN
------	-----	---	--	--	------	-----	-----

Žárovky pro vnitřní osvětlení  
Żarówky do oświetlenia wewnętrzznego  
Lampen für Innenbeleuchtung  
Interior lamps

7546	C5W	5	SV8,5-8	1/10/200	1	37912	0043168379120
				10/200	1	27771	9004102238409
				2/20 blister	1	17129	0043168354608
91701		3	SV7	10/200	2	73599	0043168936668
7575		5	SV8,5-8	1/10/200	3	38805	0043168388054
				10/200	3	27781	0043168379557
				2/20 blister	3	37956	0043168379564
7576	DIN 72601K	10	SV8,5-8	1/10/200	3	37913	0043168379137
				10/200	3	27793	9004102238683
				2/20 blister	3	35463	0043168354639
91715		10	SV8,5-8	10/200	5	73600	0043168387781
91735		10	SV8,5-8	10/200	4	73598	0043168132541
				1/10/200	4	93436	0043168379908
7592		15	SV8,5-8	10/200	6	27801	9004102349440
				2/20 blister	6	38803	0043168388030
7593		18	SV8,5-8	10/200	6	27803	9004102349457
7585		10	SV8,5-8	2/20 blister	4	39459	0043168394598

Miniaturní halogenové žárovky  
Żarówky halogenowe miniaturowe  
Miniatur-Halogenlampen  
Miniature halogen lamps

58540		5	BA9s	1/20	7	34930	9004102349303
58560		10	BA9s	1/20	7	34926	9004102349266
52830U	H6W	6	BAX9s	1/10/100	8	38849	0043168388498
				1/10 blister	8	38850	0043168388504

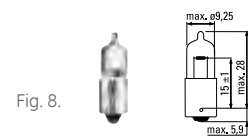
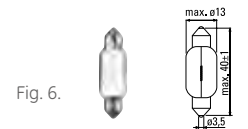
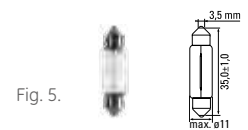
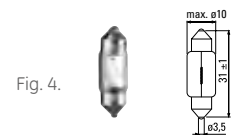
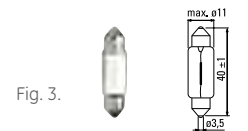

replacable with OEM lamps

Type	ECE	W			Fig.	SKU	EAN
2619	R5W	5	BA15s	1/10/200	1	37897	0043168378970
				10/200	1	17253	9004102238270
				2/20 blister	1	17136	0043168353984
2619T	R5W	5	BA15s	10/200	2	20112	0043168201124
2641	R10W	10	BA15s	1/10/200	1	37899	0043168378994
				10/200	1	17256	9004102238348
				2/20 blister	1	17134	0043168354059
2641T	R10W	10	BA15s	10/200	3	20113	0043168201131
2696	DIN 72601J	2	BA7s	10/200	4	27393	9004102349242
				2/20 blister	4	38855	0043168388559
2656		3	BA9s	10/200	5	26741	0043168936927
2660		2	BA9s	10/200	5	26742	9004102349358
				2/20 blister	5	37960	0043168379601
2662	T4W	4	BA9s	1/10/200	6	37900	0043168379007
				10/200	6	27347	9004102238379
				2/20 blister	6	17137	0043168354509
5301		1,2	W2x4,6d	1/10/200	7	42804	0043168379076
				10/200	7	42799	9004102238669
				2/20 blister	7	35451	0043168354516
91605		2	W2x4,6d	10/200	7	97987	0043168936521
91609 PS*		0,5	W2x4,6d	10/200	8	93678	0043168936781

\* PS - Plastic cap

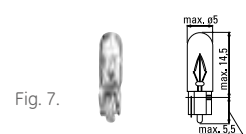
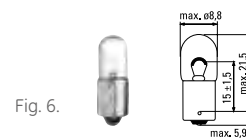
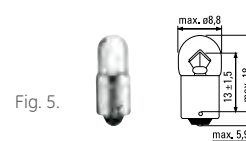
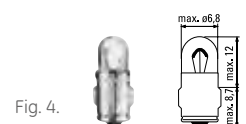
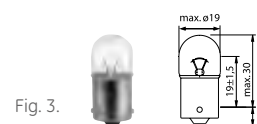
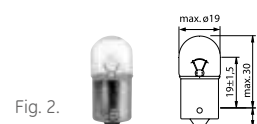



Type	ECE	W			Fig.	SKU	EAN
Celoskleněné žárovky a žárovky s plastovou patičí Žárovky całoszkłane lub z trzonkiem plastikowym Glassockellampen mit und ohne Steckfassung Wedge base lamps with and without plastic cap							
5301 PS*		1,2	B8,5d	1/10/200	1	93438	0043168379885
				10/200	1	13264	0043168132640
				2/20 blister	1	39462	0043168394628
91641 PS*		1,2	B8,4d	10/200	2	93673	0043168936736
91645 PS*		2	BX8,4d	10/200	3	93656	0043168936569
91646 PS* 14V		1,12	B8,4d	10/200	4	93657	0043168936576
5303 PS*		2	B8,5d	10/200	5	93659	0043168936590
91695 PS* 14V		1,4	HRQ	10/200	6	93664	0043168936644
91696 PS*		1,8	EBS R11	10/200	7	93665	0043168936651
504	W3W	3	W2,1x9,5d	1/10/200	8	41952	0043168379106
				10/200	8	27887	9004102238492
				2/20 blister	8	35452	0043168354523
501	W5W	5	W2,1x9,5d	1/10/200	9	41961	0043168379113
				10/200	9	27888	0043168924580
				2/20 blister	9	17138	0043168354530
501NB	W5W	5	W2,1x9,5d	10/200	10	97387	0043168936552
				2/20 blister	10	93011341	0064894508172
501NA	WY5W	5	W2,1x9,5d	10/200	11	21512	0043168924658
				2/20 blister	11	90199	0043168901994
921	W16W	16	W2,1x9,5d	10/200	12	21513	0043168215138
WY16WNAL	WY16WNAL	16	W2,1x9,5d	10/200	13	93032367	0064894538834
				2/20 blister	13	93032366	0064894538827

\* PS - Plastic cap

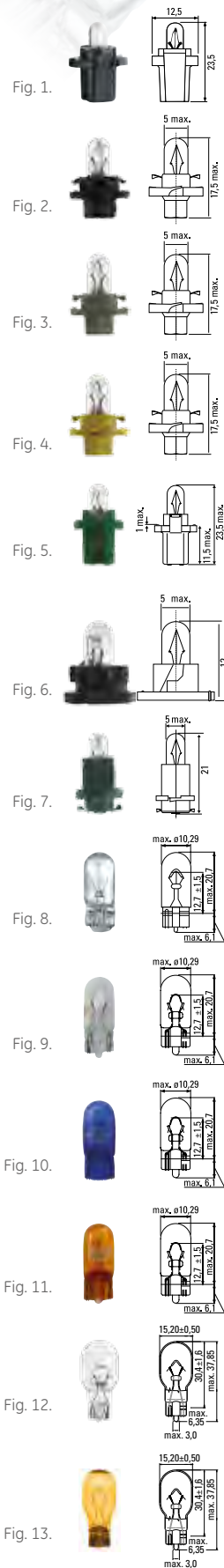

replacable with OEM lamps

# Heavy Star



 *24V žárovky pro nákladní automobily s delší životností a zvýšenou robustností*

 *Żarówki 24V o dużej trwałości i wzmocnionej konstrukcji do samochodów ciężarowych i autobusów*

 *24V Lampen für LKW und Busse mit längerer Lebensdauer und höherer Robustheit*

 *24V Truck lamps with longer life and increased robustness*

Type	ECE	W			Fig.	SKU	EAN
------	-----	---	--	--	------	-----	-----

## Heavy Star - Halogen headlight lamps

Žárovky do hlavních světlometů  
 Żarówki do reflektorów głównych - światła drogowe i mijania  
 Hauptscheinwerferlampen  
 Headlight lamps - upper and lower beam

50320/1U_HDL	H1	70	P14,5s	1/10/100	1	61493	0043168614931
50350U_HDL	H3	70	Pk22s	1/10/200	2	61496	0043168614962
50450HDLU	H4	75/70	P43t	1/10/100	3	61494	0043168614948
58521HDLU	H7	70	Px26d	1/10/100	4	61495	0043168614959

## Heavy Star - Miniature lamps

Žárovky pro obrysová, brzdová a směrová světla  
 Żarówki pozycyjne, stopowe i do kierunkowskazów  
 Blink-, Brems- und Schlußlichtlampen  
 Tail, direction, parking and indicator lamps

1060HDL	P21W	21	BA15s	10/200	5	77095	0043168770958
				2/20 blister	5	99604	0043168996044
1061HDL	P21W	21	BA15d	10/200	6	77097	0043168770972
1073HDNAL	PY21W	21	BAU15s	10/200	7	77329	0043168773294
2627HDL	R5W	5	BA15s	10/200	8	77334	0043168773348
2643HDL	R10W	10	BA15s	10/200	9	77342	0043168773423
2661HDL	T4W	4	BA9S	10/200	10	61485	0043168614856
				2/20 blister	10	99605	0043168996051

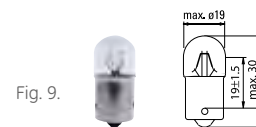
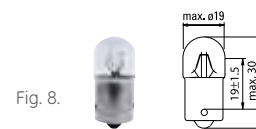
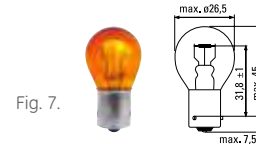
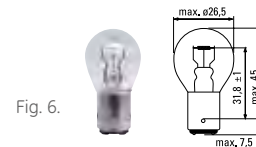
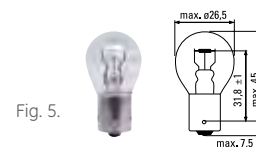
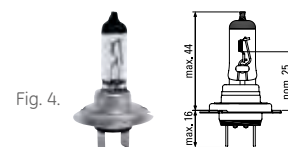
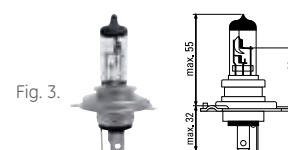
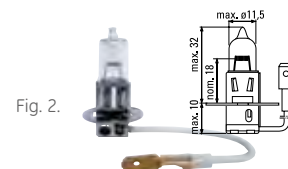
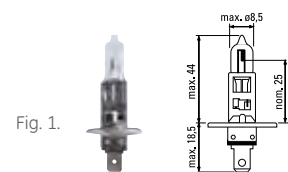



Type	ECE	W			Fig.	SKU	EAN
------	-----	---	--	--	------	-----	-----

Žárovky do hlavních světlometů  
 Żarówki do reflektorów głównych - światła drogowe i mijania  
 Hauptscheinwerferlampen  
 Headlight lamps - upper and lower beam

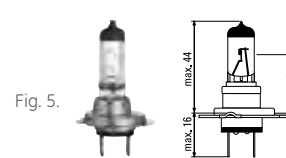
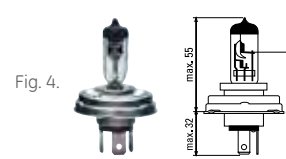
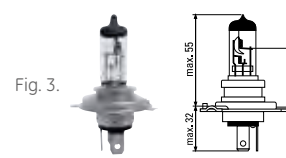
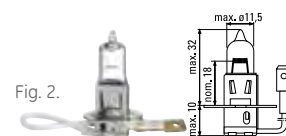
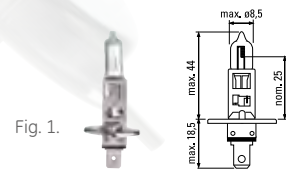
H1	<b>50320/1U</b>	H1	70	P14,5s	1/10/100	1	23793	9004102237938
					1/10 blister	1	38679	0043168386791
H3	<b>50350U</b>	H3	70	Pk22s	1/10/200	2	21149	9004102211495
					1/10 blister	2	38674	0043168386746
	<b>50400U Rally*</b>		100	Pk22s	1/10/200	2	38659	0043168386593
H4	<b>50450HU</b>	H4	75/70	P43t	1/10/100	3	38836	9004102237402
					1/10 blister	3	91579	0043168915793
	<b>52080</b>	H4	75/70	P45t	1/10/100	3	43066	9004102237471
	<b>52710HU Rally*</b>		100/70W	P43T	1/10/100	3	94938	0043168386647
H7	<b>58521U</b>	H7	70	Px26d	1/10/100	5	38838	0043168388382
					1/10 blister	5	45691	0043168456913





Rally\* - OFF ROAD use only

Type	ECE	W			Fig.	SKU	EAN
1060HD*	P21W	21	BA15s	1/10/200	1	37895	0043168378956
				10/200	1	17222	9004102348849
1061HD*	P21W	21	BA15d	10/200	2	17225	9004102349921
2626HD*	R5W	5	BA15d	10/200	3	17309	9004102349983
2627HD*	R5W	6	BA15s	1/10/200	4	37898	0043168378987
				10/200	4	17311	9004102349396
2643HD*	R10W	10	BA15s	1/10/200	5	37958	0043168379588
				10/200	5	17313	9004102349402
2661HD*	T4W	4	Ba9s	10/200	6	27341	9004102349334

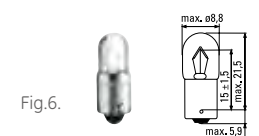
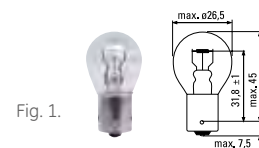
\* Žárovky Heavy Duty  
Žárovky Heavy Duty (HD) wstrząsoodporne  
Heavy-Duty-Lampen  
Supported Heavy Duty (HD) lamps



replacable with OEM lamps

Type	ECE	W			Fig.	SKU	EAN
Žárovky pro obrysová, brzdová a směrová světla Žárovky pozycijne, stopowe i do kierunkowskazów Blink-, Brems- und Schlußlichtlampen Tail, direction, parking and indicator lamps							
2626	R5W	5	BA15d	10/200	1	17308	9004102349990
2627	R5W	5	BA15s	10/200	2	17310	9004102238294
2643	R10W	10	BA15s	10/200	3	17312	9004102238355
2692	DIN 72601J	3	BA7s	10/200	4	27380	9004102349259
2661	T4W	4	BA9s	10/200	5	27327	9004102238393
2663		2	BA9s	10/200	6	27355	9004102349341
91602		1,2	W2x4,6d	10/200	7	65718	0043168132565
				1/10/200	7	65717	0043168379816
5302PS*		1,2	B8,5d	1/10/200	8	93442	0043168387774
				10/200	8	13269	0043168132695
91693		1,2	EBS R11	10/200	9	93662	0043168936620
5305	W3W	3	W2,1x9,5d	1/10/200	10	97226	0043168387767
				10/200	10	65830	0043168132619
91622	W5W	5	W2,1x9,5d	10/200	10	65680	0043168936545

\* PS - Plastic cap

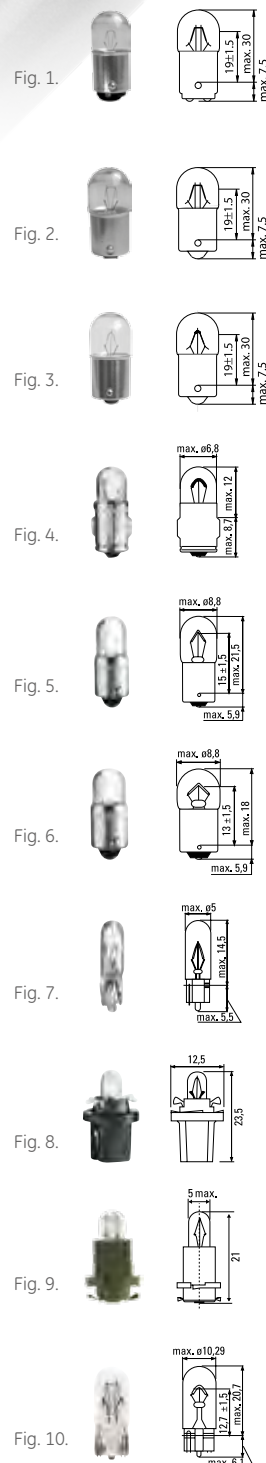

Type	ECE	W			Fig.	SKU	EAN
------	-----	---	--	--	------	-----	-----

Žárovky pro vnitřní osvětlení  
Żarówky do oświetlenia wewnętrznego  
Lampen für Innenbeleuchtung  
Interior lamps

7552	C5W	5	SV8,5-8	10/200	1	27773	9004102238454
91716		10	SV8,5-8	10/200	1	73601	0043168936699
7579		5	SV8,5-8	10/200	2	27788	0043168388061
7580		10	SV8,5-8	10/200	2	27795	9004102349419
7594		15	SV8,5-8	10/200	3	27802	0043168388078
7595	DIN 72601K	18	SV8,5-8	10/200	3	27806	0043168388092

Žárovky pro obrysová, brzdová a směrová světla  
Żarówky pozycyjne, stopowe i do kierunkowskazów  
Brems-, Blink- und Schlußlichtlampen  
Tail, stop and direction lamps

1115		15	BA15s	10/200	4	17238	0043168387422
1117	DIN 72601R	18	BA15s	10/200	4	17240	0043168387446
1060	P21W	21	BA15s	10/200	5	17221	9004102238072
1061	P21W	21	BA15d	10/200	6	17223	9004102349938
1073	PY21W	21	BAU15s	10/200	7	17250	9004102344520
1078	P21/5W	21/5	BAY15d	1/10/200	8	38731	0043168387316
				10/200	8	17232	9004102238133
				2/20 blister	8	38727	0043168387279
54400	H21W	21	BAY9S	10/200	9	94715	0043168947152

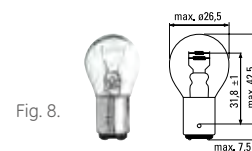
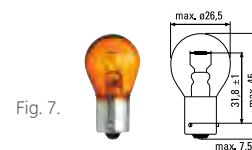
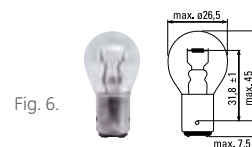
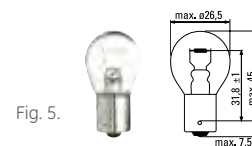

replacable with OEM lamps

# Lamp kits

## Premium "QUAD kits"

CONTENT		SKU	EAN
2XH4 Megalight Ultra +90 + 2X 501NB W5W	1/10	99627	0043168996273
2XH7 Megalight Ultra +90 + 2X 501NB W5W	1/10	99628	0043168996280
2XH1 Megalight Ultra +90 + 2X 501NB W5W	1/10	99629	0043168996297
2XH4 Sportlight+50 + 2X 501NB W5W	1/10	99666	0043168996662
2XH7 Sportlight+50 + 2X 501NB W5W	1/10	99667	0043168996679
2XH1 Sportlight+50 + 2X 501NB W5W	1/10	99668	0043168996686



*Servisní krabičky autožárovek a pojistek pro osobní automobily*  
*Zestawy żarówek samochodowych*  
*Ersatzdose*  
*Emergency Kits*

CONTENT		SKU	EAN
H4, PY21W, P21/5W, P21W, R5W, C5W, W5W, T4W, normal fuses 10A, 15A, 20A, mini fuses 7,5A, 10A, 20A	1/10	70693	0043168706933
H1, PY21W, P21/5W, P21W, R5W, C5W, W5W, T4W, normal fuses 10A, 15A, 20A, mini fuses 7,5A, 10A, 20A	1/10	70706	0043168707060
H7, PY21W, P21/5W, P21W, R5W, C5W, W5W, T4W, normal fuses 10A, 15A, 20A, mini fuses 7,5A, 10A, 20A	1/10	70694	0043168706940
H1+H7, PY21W, P21/5W, P21W, R5W, C5W, W5W, T4W, normal fuses 10A, 15A, 20A, mini fuses 7,5A, 10A, 20A	1/10	70707	0043168707077
24V H1+H7, PY21W, P21/5W, P21W, R5W, C5W, W5W, T4W, normal fuses 10A, 15A, 20A, mini fuses 7,5A, 10A, 20A	1/10	96754	0043168967549
H1, P21/5W, P21W, R5W, C5W, fuses 10A, 15A, 20A	1/10	92751	0043168927512
H4, P21/5W, P21W, R5W, C5W, fuses 10A, 15A, 20A	1/10	92752	0043168927529
H7, P21/5W, P21W, R5W, C5W, fuses 10A, 15A, 20A	1/10	92753	0043168927536
H1+H7, P21/5W, P21W, R5W, C5W, fuses 10A, 15A, 20A	1/10	92755	0043168927550





# Displays

**GE wall displays** Vacuum formed plastic body and positions for boxes, foam insert for miniature lamps

**Defined content for 161 lamps - main halogens and miniatures.** Shipped as empty (sku 88653) or filled (sku 82881).



**Defined content for 121 lamps - main halogens and miniatures.** Shipped as empty (sku 98416).



**GE wall cupboards** Vacuum formed plastic body, including lamp tester



**Defined content for 591 lamps - main halogens and miniatures.** Shipped as empty (sku 64983) or filled (sku 65234).



**Defined content for 680 lamps main halogens and miniatures.** Shipped as empty (sku 98417).

**GE wall or counter display**

Type	Code
Empty display	75040
Sportlight	75041
Megalight Ultra	75042

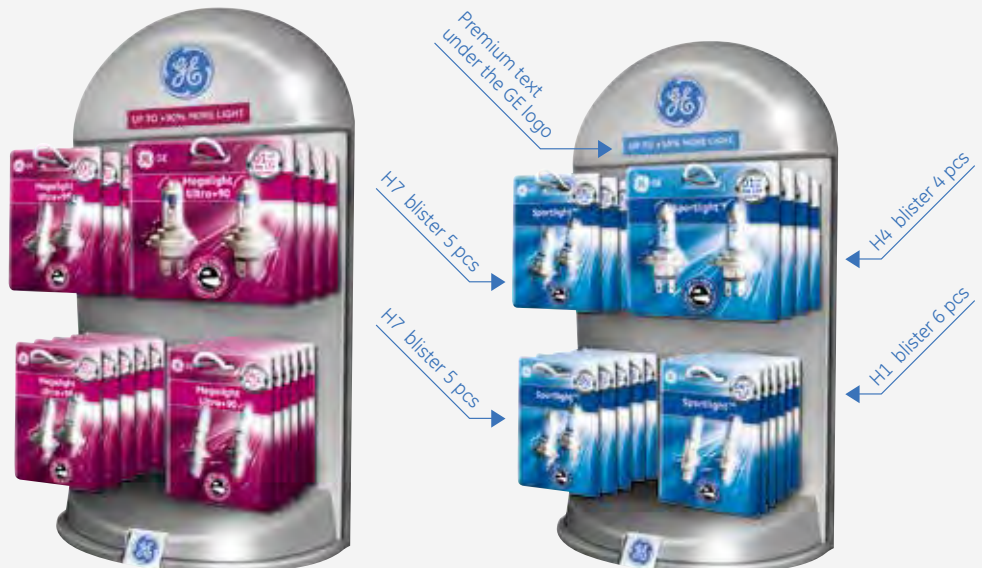

# Balení – Opakowania – Verpackungen – Packaging

## GE auto aftermarket pack concept

GE Lighting – has been a leading supplier to Automotive OEM and Aftermarket customers throughout the world for many decades. We continue our pioneering work to offer advanced solutions and benefits that can fulfill our customers' needs.

Our brand is the symbol of our heritage, and of the quality and trust we have delivered to our customers. It embodies our commitment to anticipate and meet their changing needs. It represents the imagination we use to address those needs in a manner that reflects our values.

As a result of continuous efforts to fulfill our customers' changing needs - GE has developed the aftermarket packaging concept. The main objective of our redesigned packaging is to enhance the shopping experience and drive upsell.

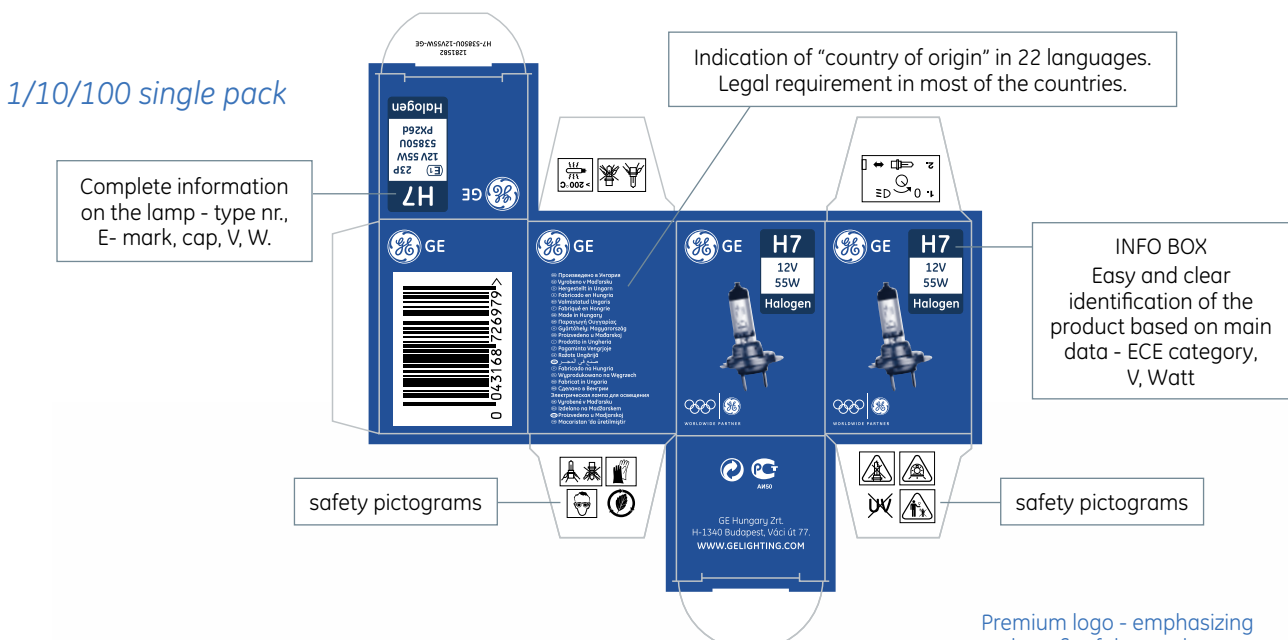

## GE twinbox/display pack

Translation of the premium feature/benefit explanation in 11 languages.



## GE 10-way pack



# GE Blister

## Our redesigned blister pack has the following advantages:

**GLOBAL:** packages reflect a “world view”, display the elements of environmental and regulatory requirements, use multiple languages

**TRUSTED:** make the purchase easier and clearer, simplified messaging that is repeated on all platforms

**PRECISE:** package information is clear and states features prominently

**APPROACHABLE, SIMPLE:** Easy to understand and right for the purchaser, helping them to decide which product is good for them. Provides differentiation between standard range and premium ranges by using color coding.



Info circle with simplified nr. that allows quick search/identification in the GE lampguide. Clear and simple information on the specific product

description of the lamp function in 10 languages

country of origin in 22 languages

safety pictograms



original equipment logo + translation in 8 languages, emphasizing GE OEM presence

lamp drawing with E-mark

## Colour coded packages tied directly to POS messaging for easy identification:

**STANDARD range** - describe the standard categories, D2 discharge, 12V-24V halogen and miniature lamps

**PREMIUM range** with feature/benefit logo, explain how one product differs from another, and why it is most appropriate for its task - rationalize the move to upsell in the halogen and miniature lamp categories

### Standard ranges

- D2 gas discharge lamps
- 12V halogen and miniature lamps
- 24V halogen and miniature lamps











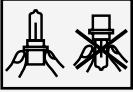

### Premium ranges

- Megalight ultra +120
- Megalight ultra +90
- Megalight plus 50
- Sportlight
- Extra life
- Heavy Star
- Rally
- Motorcycle

# GE Blister range

Product Code	Type	Designation	Simplified number	Lamp in blister	Wattage	Volt	EAN code
17119	50310U	H1	04	1	55W	12V	0043168354301
19758	50310MPU	H1 Megalight Plus 50	04MPU	2	55W	12V	0043168197588
96948	50310XU	H1 Megalight Ultra - Plus 90	04XU	2	55W	12V	0043168969482
98266	50310NU	H1 Megalight Ultra - Plus 120	04NU	2	55W	12V	0043168982665
19685	50310LU_DPU	H1 Extra Life	04DPU	2	55W	12V	0043168196857
73343	50310NHSU	H1 Sportlight	04NHSU	2	55W	12V	0043168908344
93012845	50310SBU	H1 Sportlight Ultra	04SBU	2	55W	12V	0064894521805
35434	52140U	H1 Rally - offroad	104	1	100W	12V	0043168354349
38679	50320U	H1	74	1	70W	24V	0043168386791
17117	50340U	H3	05	1	55W	12V	0043168354325
37963	52130U	H3 Rally - offroad	105	1	100W	12V	0043168379632
38674	50350U	H3	75	1	70W	24V	0043168386746
17123	58520U	H7	03	1	55W	12V	0043168354356
97131	58320NHSU	H7 Sportlight	03NHSU	2	55W	12V	0043168887892
93012861	58520SBU	H7 Sportlight Ultra	03SBU	2	55W	12V	0064894521904
19759	58520MPU	H7 Megalight Plus 50	03MPU	2	55W	12V	0043168197595
74154	58520SXU	H7 Megalight Ultra - Plus 90	03SXU	2	55W	12V	0043168741545
98282	58520SNU	H7 Megalight Ultra - Plus 120	03SNU	2	55W	12V	0043168982825
19686	58520LU_DPU	H7 Extra Life	03DPU	2	55W	12V	0003168196864
45691	58521U	H7 24V	77	1	70W	24V	0043168456913
17120	50440U	H4	01	1	60/55W	12V	0043168354417
35930	50440U	H4	01	2	60/55W	12V	0043168359306
91579	50450U	H4	71	1	60/55W	24V	0043168915793
93361	50440MPU	H4 Megalight Plus 60	01MPU	2	60/55W	12V	0043168933612
74153	50440SXU	H4 Megalight Ultra - Plus 90	01SXU	2	60/55W	12V	0043168741538
98281	50440SNU	H4 Megalight Ultra - Plus 120	01SNU	2	60/55W	12V	0043168982818
19682	50440LU_DPU	H4 Extra Life	01DPU	2	60/55W	12V	0043168196826
97132	53800NHSU	H4 Sportlight	01NHSU	2	60/55W	12V	0043168887908
93012846	50440SBU	H4 Sportlight Ultra	01SBU	2	60/55W	12V	0064894521812
18266	53060U	HB3	07	1	60W	12V	0043168182669
18267	53070U	HB4	09	1	51W	12V	0043168182676
18254	53090U	H8	13	1	35W	12V	0043168182546
18256	53100U	H9	15	1	65W	12V	0043168182560
60957	53110U	H11	16	1	55W	12V	0043168609579
17131	1057	P21W	21	2	21W	12V	0043168354066
23284	1057LFD	P21W Extra Life	21D	2	21W	12V	0043168232845
99604	1060HDL	P21W Heavy Star	81HDL	2	21W	24V	0043168996044
17130	1077	P21/5W	23	2	21/5W	12V	0043168354097
23285	1077LFD	P21/5W Extra Life	23D	2	21/5W	12V	0043168232852
38727	1078	P21/5W	93	2	21/5W	24V	0043168387279
38728	1098	20/5W	48	2	20/5W	12V	0043168387286
35931	1122	P21/4W	20	2	21/4W	12V	0043168359313
37969	1157	1157 ANSI	39	2	32/3W	12V	0043168379694
17133	1056	PY21W	22	2	21W	12V	0043168354073
17136	2619	R5W	24	2	5W	12V	0043168353984
23286	2619LFD	R5W Extra Life	24D	2	5W	12V	0043168232869
17137	2662	T4W	26	2	4W	12V	0043168354509
23292	2662LFD	T4W Extra Life	26D	2	4W	12V	0043168232920
17134	2641	R10W	30	2	10W	12V	0043168354059
37960	2660	2660	38	2	2W	12V	0043168379601
99605	2661HDL	T4W Heavy Star	86HDL	2	4W	24V	0043168996051
38855	2696	72601J	47	2	2W	12V	0043168388559
39462	5301PS	W1,2W	60	2	1,2W	12V	0043168394628
35451	5301	W1,2W	29	2	1,2W	12V	0043168354516
35452	5304	W3W	27	2	3W	12V	0043168354523
17138	501	W5W	28	2	5W	12V	0043168354530
90199	501A	WY5W	33	2	5W	12V	0043168901994
93011341	501NB	W5W	28	2	5W	12V	0064894508172
17129	7546	C5W	25	2	5W	12V	0043168354608
23308	7546LFD	C5W Extra Life	25D	2	5W	12V	0043168233088
37956	7575	7575	40	2	5W	12V	0043168379564
35463	7576	DIN 72601K	31	2	10W	12V	0043168354639
39459	7585	7585	32	2	10W	12V	0043168394598
38803	7592	72601K	42	2	15W	12V	0043168388030
38850	52830	H6W	62	1	6W	12V	0043168388504
93447	7440	W21W	50	2	21W	12V	0043168934473
512863	7443	W21/5W	49	2	21/5W	12V	5994101128631
76091	7440NA	WY21W	51	2	21W	12V	0043168760911
93032366	WY16WNAL	WY16WNAL	52	2	16W	12V	0064894538827

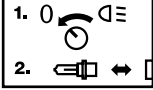
# Symbols used on the packaging

						
Do not touch with bare fingers	No disposal of as household waste	For removal and installation use appropriate eye protection	Dangerous voltage	Installation and servicing of electronic device only by qualified electrical employees	For removal and installation use appropriate gloves	Read attached instructions before use
						
Operation only in luminaire installations with protective shield	Don't let children play with bulbs	No operation of lamps with scratched or damaged glass bulb	Beware of temperature	Switch off light before re-lamping	Not suitable for household use	Use as vehicle lamp 12V or 24V

# Base stamps on the GE automotive lamps

## Halogen auto lamp marking

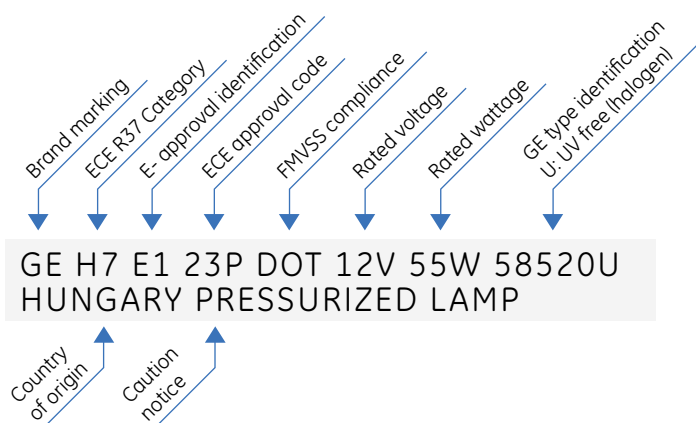

## Miniature auto lamp marking

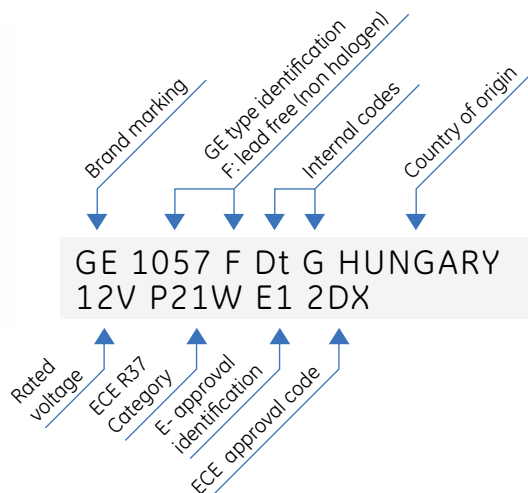

# Patice žárovek – Trzonki do żarówek – Sockelübersicht – Lamp bases



## ALBANIA, MACEDONIA

VSD Merkur d.o.o  
Exclusive Sales Representative of  
GE Hungary Kft.  
Str. Vasil Glavinov 7b/3  
1000 Skopje  
Macedonia  
Tel: (389) 2 324 4790

## ARGENTINA, PARAGUAY, URUGUAY

GE Consumer & Industrial Argentina S.A.  
Nicolás de Vedia 3616, piso 6o  
Edificio DOT – (C1430DAH)  
Buenos Aires  
Argentina  
CUIT: 30-67992375-3  
Centro de atención al cliente:  
0810 122 GECl (4324)

## AUSTRALIA

GE Lighting Australia Pty Ltd  
32 Phillip Street,  
Parramatta, NSW, 2150  
Australia  
Tel: (61) 298 066 619

## BRAZIL

GE Iluminação do Brasil CENESP  
Av. Maria Coelho Aguiar,  
215 Bloco C, 6°. andar, Jd São Luiz  
São Paulo, SP, 05804-900  
Brazil  
Tel: (55) 11 3614 1700  
Fax: (55) 11 3614 1825

## BULGARIA

VSD Merkur e.o.o.d  
Exclusive Sales Representative  
of GE Hungary Kft.  
Str. 2 Nikolai Haitov 4/31  
1113 Sofia  
Bulgaria  
Tel: (359) 2 870 5586

## CANADA

GE Lighting Canada  
2300 Meadowvale Blvd  
Mississauga, ON L5N 5P9,  
Canada  
Tel: (1) 905 858 6724  
Fax: (1) 905 8586602

## CHILE, BOLIVIA

General Electric de Chile S.A.  
Av. Isidora Goyenechea 2800,  
Las Condes – Edificio Titanium, Piso 21  
75500647 Santiago  
Chile  
Tel: (56) 2 2652 6500

## CHINA

GE Asia Headquarters  
GE Lighting Co.,Ltd.  
7 floor, Building 1, No.1. Hua Tuo Rd.  
Zhang Jiang Hi-Tech Park  
Pudong, Shanghai 201203  
China  
Tel: (86) 21 3877 7888  
Fax: (86) 21 3877 7437

## COLOMBIA, ECUADOR

GE International Inc. Sucursal Colombia  
Avenida Carrera 72 No. 80-94. Piso 12.  
Centro Empresarial Titan Plaza  
Bogota D.C.  
Colombia  
Tel: (57) 1 742 5660  
Fax: (57) 1 742 5569

## CZECH REPUBLIC, SLOVAKIA

GE International, Inc.  
Bucharova 2641/14  
158 00 Praha 5  
Czech Republic  
Tel: (420) 602 115 021

## DENMARK

GE Lighting A/S  
Park Alle 295  
2605 Brøndby  
Denmark  
Tel: (45) 8040 4945  
Fax: (45) 8040 4947

## FINLAND

GE consumer and Industrial Oy  
Kuortaneenkatu 2, 5krs PL 620,  
00031 GE – Helsinki  
Finland  
Tel: (358) 10394 2507

## FRANCE, BELGIUM, LUXEMBOURG

GE Lighting SAS  
Paris Nord II - 13. rue de la Perdrix  
B.P. 56073, Tremblay en France  
95947 ROISSY  
Charles de Gaulle Cedex  
France  
Tel: (33) (0) 1 48 63 68 00  
Fax: (33) (0)1 48 63 68 08

## GERMANY, AUSTRIA, SWITZERLAND, NETHERLANDS

GE Lighting GmbH  
Bleichstrasse 64-66  
60313 Frankfurt/M.  
Germany  
Tel: (49) 69 40125 1383  
Fax: (49) 69 40125 1393

## HONG KONG

GE International Operations Co. Inc.  
8th Floor, Lee Garden One  
33 Hysan Avenue Causeway Bay  
Hong Kong  
Tel: (852) 2100 6800  
Fax: (852) 2376 0013

## HUNGARY, GREECE, CYPRUS, MALTA

GE Hungary Kft.  
1044 Budapest  
Váci út 77.  
Hungary  
Tel: (36) 1 399 1466  
Fax: (36) 1 399 2577

## INDIA, SRI LANKA

GE India Industrial Pvt Ltd.  
73/1, 7th Floor, Summit B Brigade  
Metropolis, Garudacharpalya  
Mahadevapura Post Bangalore  
560048 Karnataka  
India  
Tel: (91) 80 4930 8000  
Fax: (91) 80 4930 8800/ 4930 8027

## INDONESIA

PT.GE Lighting Indonesia  
BRI II Tower, 27th Floor  
Jl. Jend Sudirman Kav.  
44-46 Jakarta 10210  
Indonesia  
Tel.: (62) 21 573 0500  
Fax: (62) 21 574 5241

## ITALY

GE Lighting Srl  
Centro Direzionale  
Colleoni Via Paracelso16  
20864 Agrate Brianza (MB)  
Italy  
Tel: (39) 344 014 14 31  
Fax: (39) 800784747

## JAPAN

GE Consumer Products Japan, Ltd.  
Akasaka Park Bldg.,  
5-2-20 Akasaka, Minato-ku,  
Tokyo 107-6116  
Japan  
Tel: (813) 5544 6700  
Fax: (813) 5544 6760

## KOREA

GE Lighting Korea Ltd.  
9F, POBA Gangnam Tower 343,  
Hakdong-ro, Gangnam-gu,  
Seoul, 135-820,  
Korea  
Tel: (82) 2 6201 4300  
Fax: (82) 2 6201 4344

## MALAYSIA

GE Lighting Malaysia  
Level 6, 1 Sentral, Jalan Travers  
Kuala Lumpur Sentral,  
50470 Kuala Lumpur  
Malaysia  
Tel: (603) 2273 9788

## MEXICO, CENTRAL AMERICA & CARIBBEAN

GE Commercial Materials S.de.R.L.  
de C.V. Av. Churubusco No 3900  
Norte Apartado Postal 216 64517  
Monterrey N.L. México  
Mexico  
Tel: (52) 8 318 5600  
Fax: (52) 8 318 5693

## MIDDLE EAST, AFRICA & PAKISTAN

GE International Inc.  
U-Bora Tower Business Bay  
P.O. Box 11549, Dubai  
UAE  
Tel: (971) 4 4299 666  
Fax: (971) 4 4294 291

## NEW ZEALAND

GE Lighting New Zealand  
Level 1, 8 Tangihua St.  
Auckland 1010  
New Zealand  
Tel: (64) 9 353 6706  
Fax: (64) 9 353 6707

## NORWAY

GE Lighting AS  
Postboks 4407 Nydalen  
NO-0403 Oslo  
Norway  
Tel: (47) 80 01 13 21  
Fax: (47) 80 01 10 48

## PERU

GE Lighting Peru S.A.  
Avenida Paseo de la Republica y Calle  
las Begonias, No. 415  
Piso 14 Torre Begonias  
Lima 27 – San Isidro  
Peru  
Tel: (51) 1 610 4347  
Fax: (51) 1 610 4330

## PHILIPPINES

GE Lighting Philippines, Inc.  
1873 P. Domingo St.  
1207 Makati City  
Philippines  
Tel: (63) 2 895 7051 to 53  
Fax: (63) 2 325 0377

## POLAND

GE Power Controls Sp. z o.o.  
Ul. Leszczynska 6  
43-300 Bielsko Biala  
Poland  
Tel: (48) 22 519 76 00  
Fax: (48) 22 519 76 02

## ROMANIA, MOLDOVA

VSD Merkur Lighting Group Srl  
Sales Representative of  
GE Hungary Kft.  
Luncsoara Offices Luncsoara 14,  
021232 Bucharest 2  
Romania  
Tel: (40) 314 378 630

## RUSSIA, BELARUS, ESTONIA, LATVIA, LITHUANIA, UKRAINE, KAZAHSTAN, GEORGIA, ARMENIA

OOO "GE RUS"  
Presnenskaya nab.10,  
build C ,fl. 13  
Moscow 123317  
Russia  
Tel: (7) 9169940769  
Fax: (7) 4959371112

**SERBIA, MONTENEGRO**  
VSD Merkur Group d.o.o.  
Exclusive Sales Representative of  
GE Hungary Kft.  
Str. Mihajla Pupina 10D/10S  
11070 Novi Beograd  
Serbia  
Tel: (381) 11 311 9257

**SINGAPORE**  
GE Pacific Pte Ltd  
11 North Buona Vista Drive  
Level 9, the Metropolis, Tower 2  
Singapore 138589  
Tel: (65) 6326 3319  
Fax: (65) 6326 2090

**SLOVENIA, CROATIA,  
BOSNIA AND HERZEGOVINA**  
Media Light d.o.o Exclusive agent  
of GE Hungary Kft.  
Lighting and Power Protection  
Cesta na Brdo  
109 1000 Ljubljana  
Slovenia  
Tel: (386) 1 5304366  
Fax: (386) 1 5304361

**SPAIN, PORTUGAL**  
GE Lighting/Appliances Espana, S.A.  
Rosello i Porcel, 21 - planta 10  
Edificio Meridian  
08016 - Barcelona  
Spain  
Freephone in Spain: 900 984 981  
Free fax in Spain: 900 993 610

**SWEDEN**  
GE Lighting AB  
Vendevägen 89, Box 14  
182 11 Danderyd  
Sweden  
Tel: (46) 08 51 99 22 12  
Fax: (46) 08 51 99 22 14

**TAIWAN**  
GE Lighting Taiwan  
6FL, No 8, Sec 3,  
Min Sheng E. Rd,  
Taipei 104  
Taiwan  
Tel: (886) 2 2183 7000  
Fax: (886) 2 2516 7356

**THAILAND**  
GE Lighting (Thailand) Ltd.  
27th floor, CRC Tower,  
All Seasons Place  
87/2 Wireless Road, Lumpini,  
Pathumwan, Bangkok 10330  
Thailand  
Tel: (66) 2 250 0820-4  
Fax: (66) 2 250 0825

**TURKEY, ISRAEL**  
General Elektrik Turk Ltd.  
Şti. Maslak Mah.  
Eski Büyükdere Cad. No:26 K:17  
34467 Istanbul  
Turkey  
Tel: (90) 212 214 7562  
Fax: (90) 212 214 7640

**UNITED KINGDOM,  
IRELAND**  
GE Lighting Ltd.  
Tove Valley Business Park  
Old Tiffield Road  
Towcester NN12 6PF  
United Kingdom  
Tel: (44) 7920 711761  
Fax: (44) 1543 876908

**UNITED STATES OF AMERICA**  
GE Lighting  
Nela Park, 1975 Noble Road  
Cleveland, Ohio 44112  
USA  
Tel: (1) 216 266 2121

GE Lighting is constantly developing and improving its products. For this reason, all product descriptions in this catalogue are intended as a general guide, and we may change specifications from time to time in the interest of product development, without prior notification or public announcement. All descriptions in this publication present only general particulars of the goods to which they refer and shall not form part of any contract. Data in this guide has been obtained in controlled experimental conditions. However, GE Lighting cannot accept any liability arising from the reliance on such data to the extent permitted by law.

All lamp drawings are a guide, if further technical details are required please contact your nearest sales office.

**General conditions of sale**

GE Lighting products are supplied according to GE's General Conditions of Sale. If you require a copy of these conditions please contact your nearest GE Lighting sales office.

**Prices**

A price list is available from all GE Lighting sales offices.

[www.gelighting.com/eu](http://www.gelighting.com/eu)



and General Electric are both registered trademarks  
of the General Electric Company