DECOSTAR 51 PRO 35 W 12 V 24° GU5.3

DECOSTAR 51 PRO | Halogen dichroic reflector lamps with 51 mm diameter



Areas of application

- General illumination
- Kitchen lighting
- Dining table lighting
- Mirror lighting
- Workplace lighting
- Shops
- Restaurants, hotels and similar prestigious applications

Product benefits

- Brilliant accent lighting
- Significantly lower CO₂ emissions compared to standard version
- Constant luminous intensity and constant color location throughout the lifetime
- Approved for use in open luminaires (to IEC 60598-1)
- UV filter
- Contains no mercury

Product features

- Average life: 5,000 h
- 100 % dimmable
- Color rendering index R_a: 100
- Color temperature: 3,000 K
- Diameter: 51 mm
- Deco cover
- IRC technology

Technical data

Electrical data

Nominal wattage	35.00 W
Nominal voltage	12.0 V
Rated wattage	35.00 W
Number of switching cycles	125000
Power factor λ	1.00
Claimed equiv. conventional lamp power	50 W

Photometrical data

Nominal useful luminous flux 90°	620 lm
Luminous intensity	4100 cd
Color temperature	3000 K
Light color (designation)	Warm White
Color rendering index Ra	100
Rated useful luminous flux 90°	620 lm

Light technical data

Beam angle	24 °
Starting time	0.0 s
Warm-up time (60 %)	0.00 s

Dimensions & weight

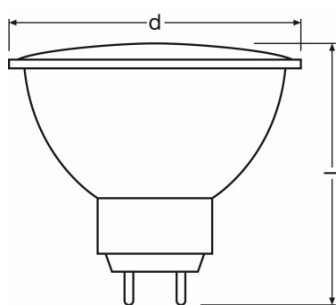

Diameter	51.0 mm
Length	46.0 mm
Overall length	45.0 mm
Outer bulb	MR51
Maximum diameter	51.0 mm

Product datasheet

Lifespan

Nominal lamp life time	5000 h
Rated lamp life time	5000 h
Lumen main.fact.at end of nom.life time	0.75

Additional product data

Base (standard designation)	GU5.3
Lamp mercury content	0.0 mg
Mercury-free	Yes

Capabilities

Burning position	Any
Dimmable	Yes

Certificates & standards

Energy efficiency class	B
Energy consumption	38 kWh/1000h

Country specific categorizations

ILCOS	HRGS//UBIB-35-12-GU5.3-51/24
-------	------------------------------

Product datasheet

Light Distribution

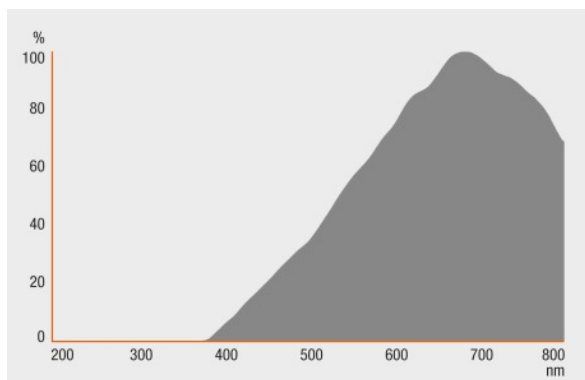

Spectral power distribution



Guarantee

Logistical Data

Product code	Product description	Packaging unit (Pieces/Unit)	Dimensions (length x width x height)	Volume	Gross weight
4050300516615	DECOSTAR 51 PRO 35 W 12 V 24° GU5.3	Shipping carton box 20	238 mm x 119 mm x 106 mm	3.00 dm ³	836.00 g

The mentioned product code describes the smallest quantity unit which can be ordered. One shipping unit can contain one or more single products. When placing an order, for the quantity please enter single or multiples of a shipping unit.

Product datasheet

References / Links

For light distribution curves see

▶ www.osram.com

Disclaimer

Subject to change without notice. Errors and omission excepted. Always make sure to use the most recent release.