

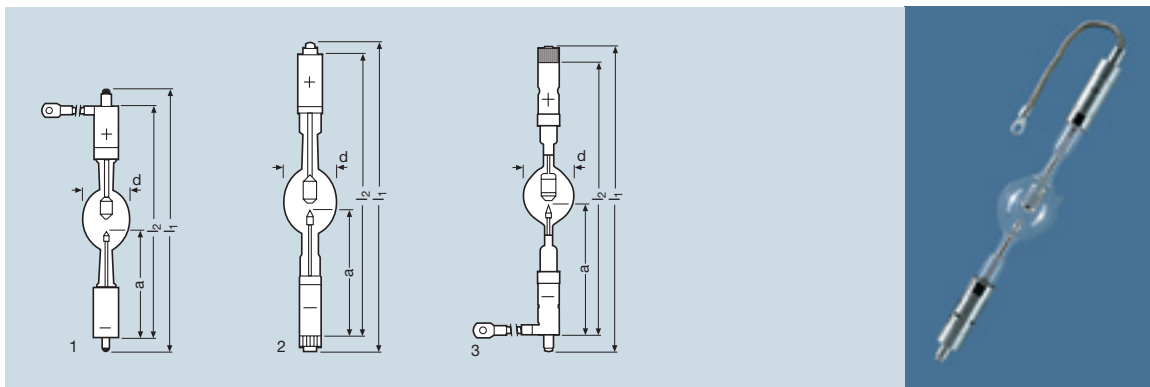











XBO® Xenon-Kurzbogenlampen



| Produkt- bezeichnung | Produkt- nummer | W | V | A | lm ³⁾ | cd ³⁾ | cd/cm ² ³⁾ | $\frac{A}{A}$ | t [h] |  ²⁾ |
|-------------------------|--------------------|------|----|-----|------------------|------------------|----------------------------------|---------------|-------|---|
| XBO 2500 W/HTP OFR | 4008321064790 | 2500 | 28 | 90 | 100000 | 9500 | 60000 | 70...100 | 1500 | s30 p30 |
| XBO 2500 W/HS OFR | 4008321081377 | 2500 | 28 | 90 | 100000 | 10000 | 80000 | 70...100 | 1500 | s30 p30 |
| XBO 3000 W/HTP XL OFR | 4008321244017 | 3000 | 29 | 100 | 130000 | 12000 | 85000 | 60...110 | 2200 | s30 p30 |
| XBO 3000 W/H XL OFR | 4008321226174 | 3000 | 29 | 100 | 130000 | 12000 | 85000 | 60...110 | 2200 | s30 p30 |
| XBO 3000 W/H CL OFR | 4008321209573 | 3000 | 29 | 100 | 130000 | 12000 | 85000 | 60...110 | 1500 | s30 p30 |
| XBO 3000 W/HS XL OFR | 4008321211798 | 3000 | 29 | 100 | 130000 | 12000 | 90000 | 60...110 | 2200 | s30 p30 |
| XBO 3000 W/HS CL OFR | 4008321210265 | 3000 | 29 | 100 | 130000 | 12000 | 90000 | 60...110 | 1500 | s30 p30 |
| XBO 3000 W/HTC OFR | 4008321064820 | 3000 | 29 | 100 | 130000 | 12000 | 85000 | 60...110 | 1500 | s30 p30 |

| Produkt- bezeichnung |  |  |  |  |  d [mm] |  l1 max. [mm] |  l2 max. [mm] |  a [mm] ¹⁾ |  |  |  No. |
|-------------------------|--|--|--|--|---|---|---|--|--|--|--|
| XBO 2500 W/HTP OFR | erf. | erf. | erf. | 1,5x6,0 | 60 | 398 | 357 | 162,5 | SFa27-14 | SFc27-14 | 2 |
| XBO 2500 W/HS OFR | erf. | erf. | erf. | 1,5x4,5 | 60 | 342 | 302 | 145 | SFaX27-9.5 | SFa27-7.9 | 1 |
| XBO 3000 W/HTP XL OFR | erf. | erf. | erf. | 1,7x5,0 | 66 | 405 | 357 | 162,5 | SFa27-14 | SFc27-14 | 2 |
| XBO 3000 W/H XL OFR | erf. | erf. | erf. | 1,7x5,0 | 66 | 428 | 382 | 167,5 | SFaX27-13 | SFaX27-14 | 1 |
| XBO 3000 W/H CL OFR | erf. | erf. | erf. | 1,7x5,0 | 55 | 428 | 382 | 167,5 | SFaX27-13 | SFaX27-14 | 1 |
| XBO 3000 W/HS XL OFR | erf. | erf. | erf. | 1,7x5,0 | 60 | 342 | 302 | 145 | SFaX27-9.5 | SFa27-7.9 | 1 |
| XBO 3000 W/HS CL OFR | erf. | erf. | erf. | 1,7x5,0 | 55 | 342 | 302 | 145 | SFaX27-9.5 | SFa27-7.9 | 1 |
| XBO 3000 W/HTC OFR | erf. | erf. | erf. | 1,7x5,0 | 66 | 398 | 350 | 165 | SFc28-13 | SFaX28-13 | 3 |

H = für horizontale Brennstellung geeignet

OFR = ozonfreie Ausführung

TC = Gewindestift mit Kabel (thread, cable)

TP = Sockel mit Gewindestift (threaded pin)

S = verkürzte Ausführung (short)

erf. = erforderlich

XL = Xtreme life

CL = Classic line

Sicherheit:

Wegen ihrer hohen Leuchtdichte, der abgegebenen UV-Strahlung und des hohen Lampeninnendruckes im kalten wie im heißen Zustand dürfen XBO®-Lampen nur in geschlossenen und eigens dafür konstruierten Gehäusen betrieben werden. Bei jeder Handhabung müssen sich die Lampen in ihrer Schutzhülle befinden. Offen dürfen sie nur unter Anwendung von entsprechenden Sicherheitsmaßnahmen gehandhabt werden. Nähere Informationen hierzu sind den entsprechenden Beipackzetteln und Bedienungsanleitungen zu entnehmen.

